



**BUREAU
VERITAS**

TEST REPORT EN 50438

Requirements for the connection of micro-generators
in parallel with public low-voltage distribution networks

Report reference number	PV140508N005
Date of issue	2014-07-21
Total number of pages	127
Testing laboratory name	Bureau Veritas Shenzhen Co., Ltd. Dongguan Branch
Address	No. 34, Chenwulu Section, Guantai Rd., Houjie Town, Dongguan City, Guangdong 523942, China
	
Applicant's name	Shenzhen SOFARSOLAR Co., Ltd.
Address	3A-1, Huake Building, East Technology Park, Qiaoxiang Road, Nanshan District, Shenzhen, China.
Test specification	
Standard	EN 50438:2007 DIN EN 50438:2008 with deviations according the national network and system protection for Turkey DIN V VDE V 0126-1-1:2006-02
Certificate	Certificate of compliance
Test report form number	EN50438
Master TRF	Bureau Veritas Consumer Products Services Germany GmbH
Test item description	Grid connected photovoltaic inverter
Trademark	
Model / Type	SOFAR 1100TL, SOFAR 1600TL, SOFAR 2200TL, SOFAR 2700TL, SOFAR 3000TL

Ratings :	SOFAR 1100TL	SOFAR 1600TL	SOFAR 2200TL	SOFAR 2700TL	SOFAR 3000TL
MPP DC voltage range [V]..... :	110-380	165-380	170-450	210-450	230-450
Input DC voltage range [V]..... :	90-400, max. 450		100-480, max. 500		
Input DC current [A]	Max.10		Max.13		
Output AC voltage [V]	230V, 50Hz				
Output AC current [A]..... :	Max.4,5	Max.7,0	Max.9,5	Max.11,5	Max.13,0
Output power [W]	1000	1500	2000	2500	2800

Testing Location	Bureau Veritas Shenzhen Co., Ltd. Dongguan Branch
Address	No. 34, Chenwulu Section, Guantai Rd., Houjie Town, Dongguan City, Guangdong 523942, China
Tested by (name and signature).....	James Huang 
Approved by (name and signature).....	Corney Zhang 
Manufacturer's name.....	Shenzhen SOFARSOLAR Co., Ltd.
Factory address	No. 8, Fulong road, Qingxi town, Dongguan city, Guangdong, China.

Document History			
Date	Internal reference	Modification / Change / Status	Revision
2014-07-21	James Huang	Initial report was written	0
Supplementary information:			

Test items particulars	
Equipment mobility.....	Permanent connection
Operating condition.....	Continuous
Class of equipment	Class I
Protection against ingress of water..	IP65 according to EN 60529
Mass of equipment [kg].....	SOFAR 1100TL, SOFAR 1600TL, SOFAR 2200TL: 11kg SOFAR 2700TL, SOFAR 3000TL: 12kg
Test case verdicts	
Test case does not apply to the test object.....	N/A
Test item does meet the requirement.....	P(ass)
Test item does not meet the requirement.....	F(ail)
Testing	
Date of receipt of test item	2014-05-08
Date(s) of performance test	2014-05-08 to 2014-07-01
General remarks:	
The test result presented in this report relate only to the object(s) tested. This report must not be reproduced in part or in full without the written approval of the issuing testing laboratory. "(see Annex #)" refers to additional information appended to the report. "(see appended table)" refers to a table appended to the report. Throughout this report a comma is used as the decimal separator.	
This Test Report consists of the following documents:	
1. Test Results	
2. Annex No. 1 – EMC Test Report	
3. Annex No. 2 – Pictures of the units	
4. Annex No. 3 – Test equipment list	

Copy of marking plate:

SOFAR SOLAR	
PV Grid Inverter	SOFAR 1100TL
Maximum DC input voltage	450V
DC voltage range	90-400V
Maximum DC input current	10A
Maximum PV Isc	12A
Nominal Grid voltage	L/N/PE 230V~
Maximum AC output current	4.5A
Nominal Grid frequency	50Hz
Maximum AC output power	1000W
Power factor	1
Ingress protection	IP65
Operating temperature range	-25-+60°C
Protective class	Class I
Manufacturer: Shenzhen SOFARSOLAR Co., Ltd. Made in China	
VDE0126-1-1, VDE-AR-N 4105, G83/2, EN50438, C10/11, AS4777, RD1699, UTE C15-712-1	
	

SOFAR SOLAR	
PV Grid Inverter	SOFAR 1600TL
Maximum DC input voltage	450V
DC voltage range	90-400V
Maximum DC input current	10A
Maximum PV Isc	12A
Nominal Grid voltage	L/N/PE 230V~
Maximum AC output current	7A
Nominal Grid frequency	50Hz
Maximum AC output power	1500W
Power factor	1
Ingress protection	IP65
Operating temperature range	-25-+60°C
Protective class	Class I
Manufacturer: Shenzhen SOFARSOLAR Co., Ltd. Made in China	
VDE0126-1-1, VDE-AR-N 4105, G83/2, EN50438, C10/11, AS4777, RD1699, UTE C15-712-1	
	

SOFAR SOLAR	
PV Grid Inverter	SOFAR 2200TL
Maximum DC input voltage	500V
DC voltage range	100-480V
Maximum DC input current	13A
Maximum PV Isc	15A
Nominal Grid voltage	L/N/PE 230V~
Maximum AC output current	9.5A
Nominal Grid frequency	50Hz
Maximum AC output power	2000W
Power factor	1
Ingress protection	IP65
Operating temperature range	-25-+60°C
Protective class	Class I
Manufacturer: Shenzhen SOFARSOLAR Co., Ltd. Made in China	
VDE0126-1-1, VDE-AR-N 4105, G83/2, EN50438, C10/11, AS4777, RD1699, UTE C15-712-1	
	

SOFAR SOLAR	
PV Grid Inverter	SOFAR 2700TL
Maximum DC input voltage	500V
DC voltage range	100-480V
Maximum DC input current	13A
Maximum PV Isc	15A
Nominal Grid voltage	L/N/PE 230V~
Maximum AC output current	11.5A
Nominal Grid frequency	50Hz
Maximum AC output power	2500W
Power factor	1
Ingress protection	IP65
Operating temperature range	-25-+60°C
Protective class	Class I
Manufacturer: Shenzhen SOFARSOLAR Co., Ltd. Made in China	
VDE0126-1-1, VDE-AR-N 4105, G83/2, EN50438, C10/11, AS4777, RD1699, UTE C15-712-1	
	

SOFAR SOLAR	
PV Grid Inverter	SOFAR 3000TL
Maximum DC input voltage	500V
DC voltage range	100-480V
Maximum DC input current	13A
Maximum PV Isc	15A
Nominal Grid voltage	L/N/PE 230V~
Maximum AC output current	13A
Nominal Grid frequency	50Hz
Maximum AC output power	2800W
Power factor	1
Ingress protection	IP65
Operating temperature range	-25-+60°C
Protective class	Class I
Manufacturer: Shenzhen SOFARSOLAR Co., Ltd. Made in China	
VDE0126-1-1, VDE-AR-N 4105, G83/2, EN50438, C10/11, AS4777, RD1699, UTE C15-712-1	
	

General product information:

The Solar converter converts DC voltage into AC voltage.

The input and output are protected by varistors to Earth. The unit is providing EMC filtering at the PV input and output toward mains. The unit does not provide galvanic separation from input to output (transformerless). The output is switched off redundantly by the high power switching bridge and two relays. This assures that the opening of the output circuit will also operate in case of a single error.

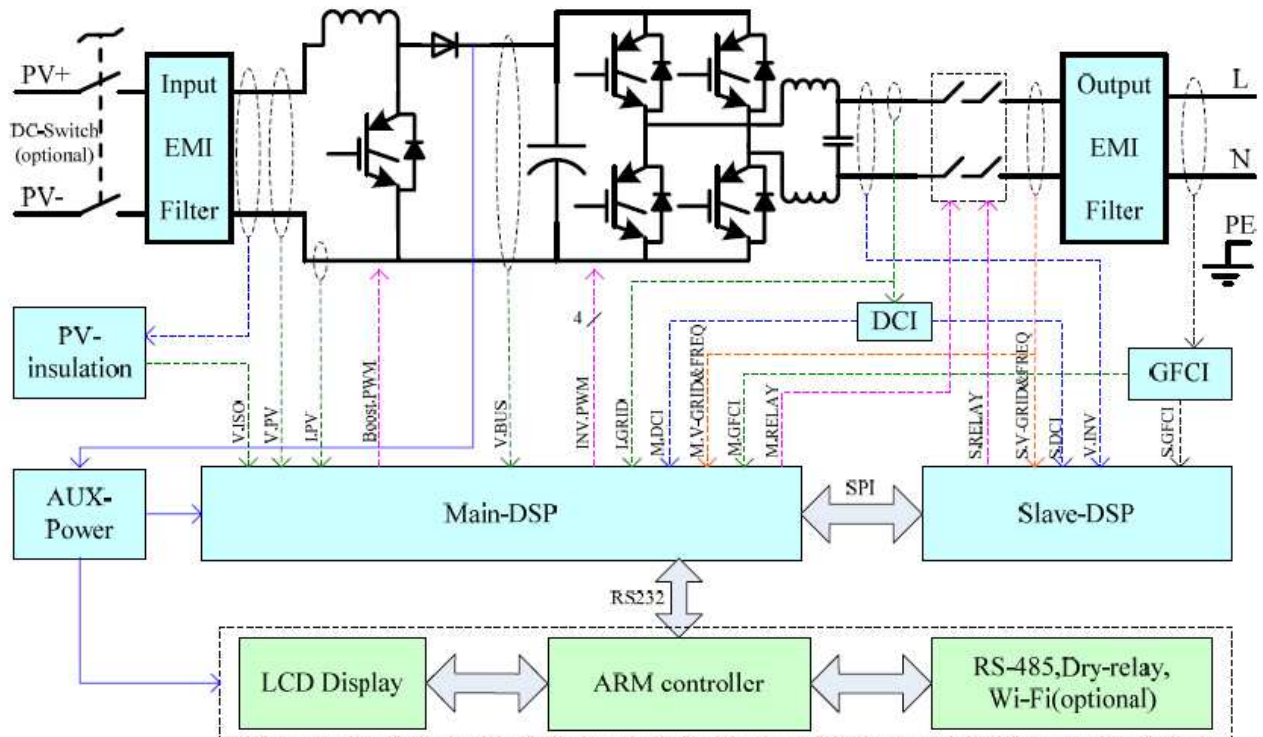

The internal control is redundant built. It consists of Microcontroller Master DSP (UC34) and Slave DSP (UC35).

The Master DSP control the relays (RYP2-RYP5) by switching signals; measures the PV voltage, PV current, Bus voltage, grid voltage and frequency, AC current with injected DC and the array insulation resistance to ground. In addition it tests the current sensors and the RCMU circuit before each start up.

The Slave DSP (UC35) is measures the grid voltage, AC current, grid frequency and residual current, also can switch off the relays (RYP2-RYP5) independently, and communicate with Master DSP (UC34) each other.

The current is measured by a current sensor. The AC current signal and the injected DC current signal are sent to the Master DSP (UC34). The Master DSP (UC34) tests and calibrates before each start up all current sensors.

The unit provides two relays in series in all output conductors. When single fault applied to one relay, alarm an error code in display panel, another redundant relay provides basic insulation maintained between the PV array and the mains. All the relays are tested before each start up.

Differences of the models

The models SOFAR 1100TL, SOFAR 1600TL, SOFAR 2200TL, SOFAR 2700TL and SOFAR 3000TL are same as in hardware except the components are in the difference table. Identical in software the output power just adjusted by software.

Difference table					
	SOFAR 1100TL	SOFAR 1600TL	SOFAR 2500TL	SOFAR 2700TL	SOFAR 3000TL
Boost inductor	2,6mH	2,6mH	1,9mH	1,9mH	1,9mH
Resistor (RP105, RP108 /RP189,RP109)	220ohm / 10Kohm	220ohm / 10Kohm	200ohm / 7,5Kohm	200ohm / 7,5Kohm	200ohm / 7,5Kohm
BUS capacitor (ECP1, ECP2, ECP3, ECP4)	2 pcs	2 pcs	3 pcs	3 pcs	3 or 4 pcs
Inverter inductor	3,4mH	2,3mH	2,1mH	1,5mH	1,3mH
Resistor (RP118, RP119, RC18 /RP120, RP121,RC22)	499 Ω, 200 Ω, 200 Ω	1 KΩ, 200 Ω, 100 Ω	1 KΩ, 330 Ω, 330 Ω	2 KΩ, 100 Ω, 100 Ω	2 KΩ, 100 Ω, 100 Ω
DC switch and Wi-Fi module are optional.					

The product was tested on:
Hardware version: V1.00
Software version: V1.00

Default interface protection settings according EN 50438:2007: (Turkey)		
Parameter	Max. clearance time	Trip setting
Over voltage	0,2s	230V +15% (264,5V)
Under voltage	1,5s	230V -15% (195,5V)
Over frequency	0,5s	50Hz +2% (51,0Hz)
Under frequency	0,5s	50Hz -6% (47,0Hz)
Reconnection time	>=20s	
Permanent DC-injection	0,5% of rated inverter output current	
Loss of main DIN V VDE V 0126-1-1:2006	Inverter shall detect and disconnect within 5s	
<p>The stated currents and voltages are 'true r.m.s.'-values. The voltages in this table are - phase-to-neutral in 230 V single phase systems and 230/400 V systems, - phase-to-phase in a multiphase 230 V system.</p>		
<p>*Over voltage – stage1: 10min mean value corresponding to EN 50160 Tolerances on trip values: - Voltage: +/- 1% of the nominal voltage; - Frequency: +/- 0,5% of the nominal frequency - Clearance time: +/- 10%</p>		

EN 50438:2007			
Clause/§	Requirement:	Remark:	Verdict

1	Scope (Micro-generators up to 16A on the public low-voltage grid)		
----------	--	--	--

2	Normative references		
		EN 50110 series	
		EN 50160	
		EN 60255-6	
		EN 60664-1	
		EN 61000-3-2	
		EN 61000-3-3	
		EN 61000-6-1	
		EN 61000-6-3:2001 + A11:2004	
		HD 384 / HD 60364 series	
		IEC 60364-5-55	

3	Terms and definitions		
----------	------------------------------	--	--

4	Connection requirements:		
4.1	The electrical installation.....:	The installation shall be in compliance with HD 384 series and national and local regulation.	P
4.1.1	Installation instructions.....:	Maintenance in accordance with the instructions issued by the manufacturer	P
4.1.2	Over-current protection.....:	The manufacturer recommends an over-current protection device in the manual	P
4.1.3	Earthing.....:	Earthing shall be according to HD 384.5.54 / IEC 60364-5-55 and the relevant national standards.	P
4.2	Interface protection		P
4.2.1	General.....:	The interface protection, monitoring and control functions are integral part of the inverter.	P
4.2.1.1	Default settings versus national settings.....:	Default settings of table 2 are applied	P
4.2.1.2	Response to protection operation.....:	See table 4.2.1.2 below	P
4.2.1.3	Accessibility of isolation switching devices.....:	The transformerless unit provides two disconnection devices in series.	P

EN 50438:2007			
Clause/§	Requirement:	Remark:	Verdict
4.2.1.4	Place of the interface protection.....:	The interface protection is integral part of the inverter and conform to EN 60255-6 or equivalent. The manufacturer declares conformity of his product to this standard within the CE declaration of conformity.	P
4.2.1.5	Changing settings of the interface protection.....:	It is not possible for the user to alter the interface protection settings	P
4.2.1.6	Combined protection devices for multiple generators.....:	The proper combined working of the protection is ensured	P
4.2.2	Interface protection settings.....:	Default interface protection settings are applied, see table 4.2.2 below	P
4.2.3	Loss of Mains protection.....:	Loss of mains protection is required (see Annex A)	P
4.2.4	Automatic reconnection after a network outage....:	>20s, see table 4.2.2 below	P
4.2.5	Synchronisation.....:	Automatic synchronisation of the inverter	P
5			
Power quality:			
5.1	Electromagnetic emission / immunity.....:	The inverter complies with the requirements of the EMC directive, see attached EMC report in Annex 1	P
	EN 61000-6-1 (immunity)		P
	EN 61000-6-3 + A11 (emission)		P
	EN 61000-3-2 (harmonics)		P
	EN 61000-3-3 (voltage fluctuations and flicker)		P
5.2	DC injection.....:	Nearly no DC injection, see table 5.2 below	P
5.3	Power factor.....:	See table 5.3 below	P
6			
Operation and safety of the micro-generator			
6.1	General.....:	The unit operates safely over the declared operating range	P
6.2	Safety.....:	This standard does not cover safety of DNO personnel.	P

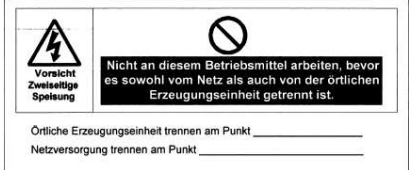
EN 50438:2007			
Clause/§	Requirement:	Remark:	Verdict
6.3	Information plate.....:	At least information of manufacturers name, identification, rated power, nom. voltage, nom. frequency, phases and power factor, see above marking plate.	P
6.4	Labelling.....:	The unit provides the following warning label: 	P
6.5	Maintainance and routine testing.....:	The manufacturer provides information for maintainance in the manual. The units are routine tested in the factory.	P
7			
Commissioning			
7.1	General		P
	The micro-generator (including the interface protection) shall fulfil the requirements of this standard and the other applicable standards.....:	Noticed	-
	The manufacturer shall provide an installation instruction in accordance with this standard and national or regional requirements.....:	Verified, see manual.	-
	Access to the interface protection shall be tamper-proof.....:	Access just via password, provided by the manufacturer	-
	The micro-generator shall be type tested against the interface requirements of this standard.....:	Noticed, see test tables below	-
	The installation shall be carried out by installer with recognised and approved qualification	Not scope of investigation	-
7.2	Installation	Not scope of investigation	N/A
7.3	Notification		N/A
7.4	Decommissioning arrangements		N/A
7.5	Replacement arrangements		N/A
Annex			
A (normative)	Interface protection settings, national deviations	No specific national settings are supplied, the default settings in 4.2.2, table 2 are applicable	N/A
B (informative)	Notification sheets		N/A
C (informative)	Interface protection	Noticed	P

EN 50438:2007			
Clause/§	Requirement:	Remark:	Verdict
D (informative)	Type certification test results sheet	Noticed	P
E (informative)	Countries allowing extensions of the scope >16A		N/A
F (informative)	Abbreviations	Noticed	P
G (informative)	A-deviations		N/A

EN 50438:2007		
Clause	Test	Result
4.2.1.2	Response to protection operation	P
4.2.2	Interface protection settings	P
4.2.3	Loss of Mains protection	P
4.2.4	Automatic reconnection after a network outage	P
5.1	Harmonic current emission	P
5.1	Voltage fluctuation and flicker	P
5.2	DC injection	P
5.3	Power factor	P

Test Results

4.2.1.2 Response to protection operation - fault condition tests according DIN V VDE V 0126-1-1:2006-02								P
	ambient temperature [°C] :	23,8						—
	model/type of power supply :	DC : 62150H-1000S AC : 61512						—
	manufacturer of power supply :	Chroma						—
	rated markings of power supply :	DC: 0-1000V, 15kW AC: 0-300V, 18kW						—
component No.	fault	test condition		test time	fuse No.	fault condition		result
		AC	DC			AC	DC	
PV voltage detect UC1C Pin 9	Open	230V 12,63 A	450V 6,62 A	2 Min.	--	230V 0,17A	450V 0,02A	PV inverter disconnected from grid immediately, error message: ID09. (PV voltage over range)
PV current detect UC1B Pin 5	Open	230V 12,63 A	450V 6,6A	2 Min.	--	230V 0,16A	450V 0,02A	PV inverter disconnected from grid immediately, error message: ID14. (PV current over range)
GFCI detect UC2D Pin 12-13	Short	230V 12,63 A	450V 6,62 A	2 Min.	--	230V 0,16A	450V 0,02A	PV inverter disconnected from grid immediately, error message: ID12. (GFCI fault)
GFCI detect UC2C Pin 10	Short	230V 12,63 A	450V 6,62 A	2 Min.	--	230V 0,16A	450V 0,02A	PV inverter disconnected from grid immediately, error message: ID52. (GFCI fault)
Grid voltage detect UC2A Pin 3	Open	230V 12,64 A	450V 6,67 A	2 Min.	--	230V 0,17A	450V 0,02A	PV inverter disconnected from grid immediately, error message: ID15. (Grid current or voltage over range)
Grid voltage detect RC17	Open	230V 12,63 A	450V 6,62 A	2 Min.	--	230V 0,17A	450V 0,01A	PV inverter disconnected from grid immediately, error message: ID02, ID49, ID70. (Grid current or voltage under range)
Grid voltage detect RC25	Open	230V 12,64 A	450V 6,62 A	2 Min.	--	230V 0,18A	450V 0,01A	PV inverter disconnected from grid immediately, error message: ID55. (Relay fault)
Bus voltage detect RP3	Open	230V 12,61 A	450V 6,63 A	2 Min.	--	230V 0,6A	450V 0,02A	PV inverter disconnected from grid immediately, error message: ID23. (Bus voltage zero fault)
Bus voltage detect UC1A Pin2-3	Short	230V 12,56 A	450V 6,65 A	2 Min.	--	230V 0,17A	450V 0,02A	PV inverter disconnected from grid immediately, error message: ID66. (Bus voltage over range)

component No.	fault	test condition		test time	fuse No.	fault condition		result
		AC	DC			AC	DC	
Bus voltage detect RC82	Short	230V 12,56 A	450V 6,69 A	2 Min.	--	230V 0,16A	450V 0,02A	PV inverter disconnected from grid immediately, error message: ID25. (Bus voltage under range)
ISO detect RC105	Open before start	230V 0,17 A	450V 0,18 A	2 Min.	--	230V 0,17A	450V 0,02A	PV inverter can not start up, error message: ID56. (ISO fault)
AC current detect RC22	Open	230V 12,56	450V 6,68	2 Min.	--	230V 0,17A	450V 0,02A	PV inverter disconnected from grid immediately, error message: ID15. (AC current over range), QP2, QP6, QP9, RP26, RP28, RP11 damaged.
AC current detect RC21	Open	230V 12,62 A	450V 6,63 A	2 Min.	--	230V 0,16A	450V 0,02A	PV inverter disconnected from grid immediately, error message: ID15. (AC current over range).
DC current detect RC33	Open	230V 12,67 A	450V 6,69 A	2 Min.	--	230V 0,17A	450V 0,02A	PV inverter disconnected from grid immediately, error message: ID28. (DC current over range).
DC current detect RC37	Open	230V 12,54 A	450V 6,67 A	2 Min.	--	230V 0,17A	450V 0,02A	PV inverter disconnected from grid immediately, error message: ID28. (DC current over range).
DC current detect RC42	Open	230V 12,62 A	450V 6,66 A	2 Min.	--	230V 0,16A	450V 0,02A	PV inverter disconnected from grid immediately, error message: ID51. (DC current fault).
AC current detect RC61	Open	230V 12,66 A	450V 6,7A	2 Min.	--	230V 0,16A	450V 0,02A	PV inverter disconnected from grid immediately, error message: ID15, ID65. (AC voltage or current over range).
AC current detect RC80	Open	230V 12,67 A	450V 6,8A	2 Min.	--	230V 0,16A	450V 0,02A	PV inverter disconnected from grid immediately, error message: ID15, ID65. (AC voltage or current over range).
GFCI detect RP70	Open	230V 12,63 A	450V 6,66 A	2 Min.	--	230V 0,16A	450V 0,02A	PV inverter disconnected from grid immediately, error message: ID12. (GFCI fault).
GFCI detect RP80	Open	230V 12,63 A	450V 6,66	2 Min.	--	230V 0,16A	450V 0,02A	PV inverter disconnected from grid immediately, error message: ID12. (GFCI fault).
GFCI detect UP7A Pin2-3	Short	230V 12,56 A	450V 6,67 A	2 Min.	--	230V 0,17A	450V 0,02A	PV inverter disconnected from grid immediately, error message: ID12. (GFCI fault).

component No.	fault	test condition		test time	fuse No.	fault condition		result
		AC	DC			AC	DC	
PV voltage detect RP115	Open	230V 12,62 A	450V 6,67 A	2 Min.	--	230V 0,16A	450V 0,02A	PV inverter disconnected from grid immediately, no display, and reconnect to grid, error message: ID56. (ISO fault).
PV voltage detect RP115	Short	230V 12,63 A	450V 6,63 A	2 Min.	--	230V 0,16A	450V 0,02A	PV inverter disconnected from grid immediately, error message: ID09. (PV voltage over range)
ISO detect RP99	Open before start	230V 0,16 A	450V 0,02 A	2 Min.	--	230V 0,16A	450V 0,02A	PV inverter can not start up, error message: ID56. (ISO fault).
Relay detect RYP2 Pin3-4	Short before start	230V 0,16 A	450V 0,02 A	2 Min.	--	230V 016A	450V 0,02A	PV inverter can not start up, error message: ID55, ID77. (Relay fault).
Relay detect RYP3 Pin3-4	Short before start	230V 0,16 A	450V 0,02 A	2 Min.	--	230V 0,16A	450V 0,02A	PV inverter can not start up, error message: ID55, ID77. (Relay fault).
Relay detect RYP4 Pin3-4	Short before start	230V 0,16 A	450V 0,02 A	2 Min.	--	230V 0,16A	450V 0,02A	PV inverter can not start up, error message: ID55, ID77. (Relay fault).
Relay detect RYP5 Pin3-4	Short before start	230V 0,16 A	450V 0,02 A	2 Min.	--	230V 0,16A	450V 0,02A	PV inverter can not start up, error message: ID55, ID77. (Relay fault).
Grid voltage detect RP150	Open	230V 0,62 A	450V 6,67 A	2 Min.	--	230V 0,16A	450V 0,02A	PV inverter disconnected from grid immediately, error message: ID02. (Grid voltage under range)
Grid voltage detect RP150	Short	230V 12,64 A	450V 6,66 A	2 Min.	--	230V 0,16A	450V 0,02A	PV inverter disconnected from grid immediately, error message: ID01. (Grid voltage over range)
Grid voltage detect RP135	Short	230V 12,64 A	450V 6,67 A	2 Min.	--	230V 0,16A	450V 0,02A	PV inverter disconnected from grid immediately, error message: ID01. (Grid voltage over range)
Grid voltage detect RP135	Open	230V 12,61 A	450V 6,66 A	2 Min.	--	230V 0,16A	450V 0,02A	PV inverter disconnected from grid immediately, error message: ID02. (Grid voltage under range)
Loss of control CC100	Short	230V 12,61 A	450V 6,67 A	2 Min.	--	230V 0,16A	450V 0,02A	PV inverter disconnected from grid immediately, error message: DSP communicate fail
Loss of control XLC	Short	230V 12,63 A	450V 6,65 A	2 Min.	--	230V 0,16A	450V 0,02A	PV inverter disconnected from grid immediately, error message: DSP communicate fail

component No.	fault	test condition		test time	fuse No.	fault condition		result
		AC	DC			AC	DC	
Communication microcontroller defect UC34 Pin 31	Open	230V 12,64 A	450V 6,66 A	2 Min.	--	230V 0.16A	450V 0.02A	PV inverter disconnected from grid immediately, error message: ID 53 (SPI Communication fault)
Communication microcontroller defect UC34 Pin 37	Open	230V 12,64 A	450V 6,66 A	2 Min.	--	230V 0.17A	450V 0.02A	PV inverter disconnected from grid immediately, error message: ID 53 (SPI Communication fault)
Communication microcontroller defect UC34 Pin 44	Open	230V 12,63 A	450V 6,66 A	2 Min.	--	230V 0.17A	450V 0.02A	PV inverter disconnected from grid immediately, error message: ID 53 (SPI Communication fault)
Communication microcontroller defect UC34 Pin 47	Open	230V 12,64 A	450V 6,67 A	2 Min.	--	230V 0.17A	450V 0.02A	PV inverter disconnected from grid immediately, error message: ID 53 (SPI Communication fault)
<p>The errors in the control circuit simulate that the safety is even under one error ensured. The tests had been performed on the SOFAR 3000TL is valid for the SOFAR 1100TL, SOFAR 1600TL, SOFAR 2200TL and SOFAR 2700TL, since it is same as in hardware and just power derated by software.</p>								
Addendum – Shutdown device								
Each active phase can be switched. (L and N)								P
If no galvanic separation between AC and DC (PV): Two relays in series on each active phase are necessary to fulfil the basic insulation or simple separation based on the PV working voltage.								P

4.2.2 Interface protection settings – Over / under voltage (4.2.3) Automatic reconnection after a network outage						P
Test Condition			Output power: 1632W Frequency: 50+/-0,2Hz			
Phase	Limit [V]	Trip value [V]	Voltage step [V]	Reconnection time [s]	Disconnection time [ms]	Limit [ms]
L1	85% of U_n = 195,5	195,3	200V to 190V	74	1415	1500
			200V to 190V		1410	
			200V to 190V		1416	
			200V to 190V		1412	
			200V to 190V		1420	
	115% of U_n = 264,5	264,2	259V to 269V	74	162	200
			259V to 269V		156	
			259V to 269V		156	
			259V to 269V		152	
			259V to 269V		168	

Note:
Lower and upper threshold voltage shall not fall or rise below or above 2,3V of the trip value itself. The measurement shall take place at nominal frequency and any power.

The oscilloscope pictures below show the measured worst case disconnection times.

The tests had been performed on the SOFAR 3000TL is valid for the SOFAR 1100TL, SOFAR 1600TL, SOFAR 2200TL and SOFAR 2700TL, since it is same as in hardware and just power derated by software.

Undervoltage

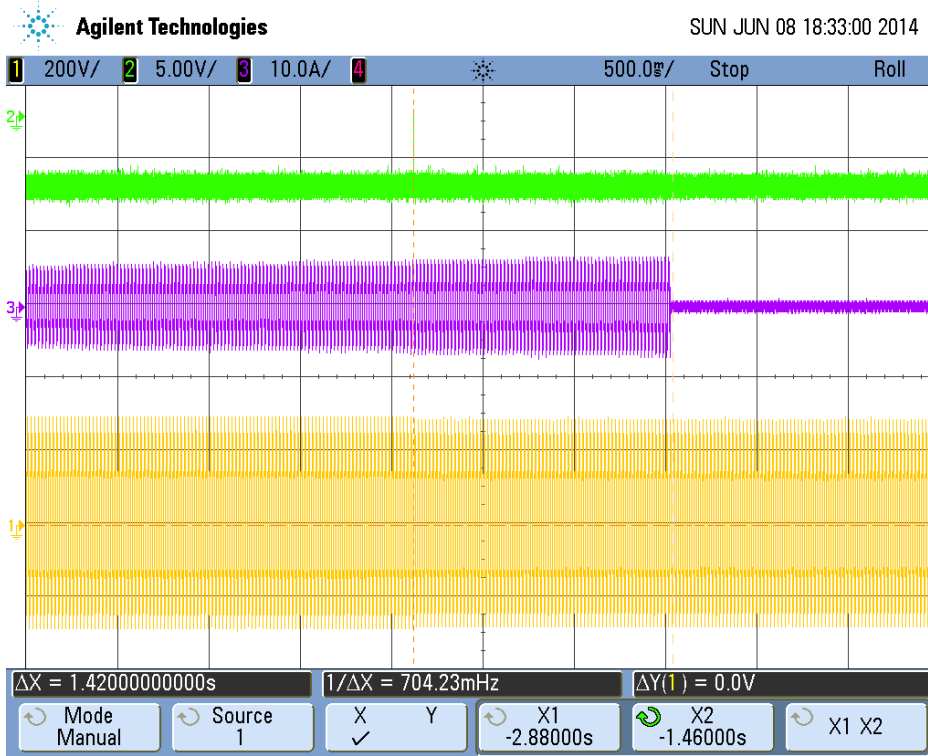

Overvoltage

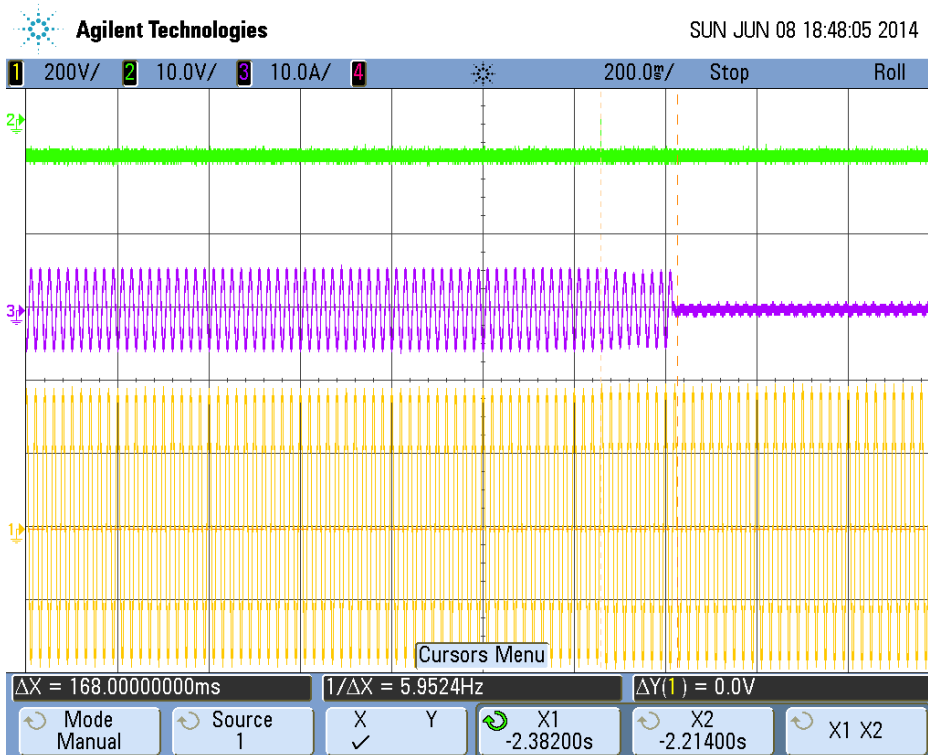

4.2.2 Measuring the rise-in voltage protection as a running 10-minute mean value Overvoltage protection according to DIN EN 50160:2000-03, 2.3			P
Setting values of the protection:	Trip value Setting [V]	264,5 V	
	Setting $T_{\text{disconnection trip value}}$ [s]	60 s	
	Setting $T_{\text{disconnection}}$ [ms]	140 ms	
Test:			
	Disconnection time [s]	Limit [s]	
a)	The voltage is set to 100% U_n and held for 600 s. Thereafter the voltage is set to 112% U_n . Disconnection must take place within 600 s.		
	Phase 1:	500 s	600 s
	Phase 2:	N/A	
	Phase 3:	N/A	
b)	The voltage is set to U_n for 600 s and then to 108% U_n for 600 s. No disconnection should take place.		
	Phase 1:	No disconnection	Disconnection should not take place.
	Phase 2:	N/A	
	Phase 3:	N/A	
c)	The voltage is set to 106 % U_n and held for 600 s. Thereafter the voltage is set to 114 % U_n . The disconnection should last for half the period as in Point a)*		
	Phase 1:	283 s	300 s
	Phase 2:	N/A	
	Phase 3:	N/A	
Test:			
a) This test serves as proof of the measurement accuracy and the maximum set time.			
b) This test serves as proof of the measurement accuracy.			
c) This test serves as proof of the correct formation of the 10 minute running mean value.			
Assessment criterion:			
The permitted tolerance between setting value and trip value of the voltage may not exceed $\pm 1\%$ of U_N .			
<u>Limit values:</u>			
Rise-in voltage protection 1,1 U_N after a max. 600 s, the switch off after 200 ms.			
Note:			
If only one integrated protection is used for the power generation systems, the value of the rise-in voltage protection of 1,1 U_N may not be changed.			
The tests had been performed on the SOFAR 3000TL is valid for the SOFAR 1100TL, SOFAR 1600TL, SOFAR 2200TL and SOFAR 2700TL, since it is same as in hardware and just power derated by software.			

4.2.2 Interface protection settings – Over / under frequency (4.2.4) Automatic reconnection after a network outage								P
Test conditions	Output power: 1632W $U_N = 230V_{ac}$							
	Under frequency				Over frequency			
Parameter	Frequency	Time			Frequency	Time		
Output Voltage		~85% of U_N	U_N	~110% of U_N		~85% of U_N	U_N	~110% of U_N
Limit	47,00Hz	500ms	500ms	500ms	51,00Hz	500ms	500ms	500ms
Trip value [Hz]		47,00Hz	47,00Hz	47,00Hz		51,02Hz	51,02Hz	51,02Hz
Disconnection time [ms]	47,5Hz to 46,5Hz	430	426	435	50,5Hz to 51,5Hz	422	432	396
		425	435	418		424	434	414
		430	420	432		422	416	434
		418	424	420		420	432	420
		424	436	422		416	422	430
Reconnection time [s]:	≥ 20	74s			≥ 20	74s		
<p>Note: It was measured at a continuous change of frequency of 1Hz/s at lower, nominal and upper U_N and arbitrary output power. The trip value was determined manually by reducing the frequency in 10mHz steps. When the trip value is known (e.g. 48,02Hz), the ac-source is programmed to run from e.g. 48,50Hz to 47,50Hz with 1Hz/s. The disconnection time is calculated by the measured time minus the 480ms from 48,50Hz to 48,02Hz.</p> <p>The oscilloscope pictures below show the measured worst case disconnection times.</p> <p>The tests had been performed on the SOFAR 3000TL is valid for the SOFAR 1100TL, SOFAR 1600TL, SOFAR 2200TL and SOFAR 2700TL, since it is same as in hardware and just power derated by software.</p>								

Under frequency

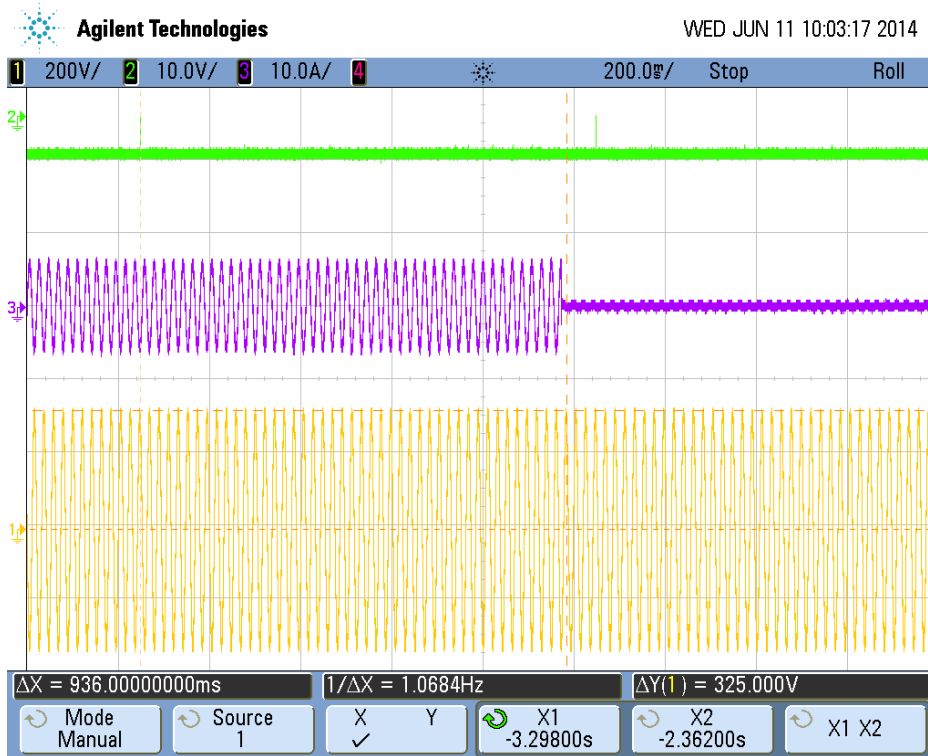

Over frequency

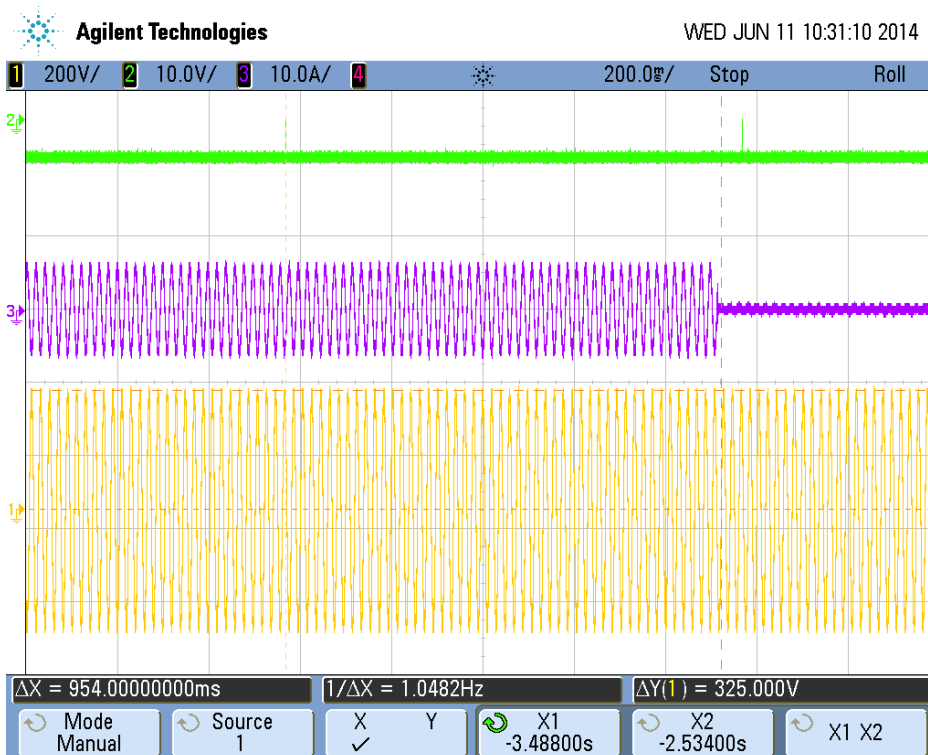

4.3.2. Loss of Mains according DIN V VDE V 0126-1-1:2006-02				P
Test conditions	Frequency 50+/-0,1Hz $U_N = 230\pm 3V_{ac}$ Distortion factor of chokes <2% Quality Q>2			
Disconnection limit	5s			
Output power	Min. ~25% disconnect time [ms]	Medium ~50% disconnect time [ms]	Max. ~100% disconnect time [ms]	
Osc. Parameter				
- 5%	0,158	0,204	0,180	
- 4%	0,146	0,128	0,071	
- 3%	0,202	0,108	0,104	
- 2%	0,235	0,384	0,391	
- 1%	0,420	0,398	0,452	
0 %	0,489	0,378	0,468	
+1 %	0,422	0,431	0,485	
+2 %	0,130	0,115	0,109	
+3 %	0,190	0,202	0,111	
+4 %	0,167	0,203	0,140	
+5 %	0,170	0,048	0,100	
Parameter at 0%	L=120,02 mH R=76,12 Ω C=84,66 μF	L=59,48 mH R=37,84 Ω C=169,75 μF	L=29,87 mH R=18,93 Ω C=338,59 μF	
<p>Note: The oscilloscope pictures below show the measured worst case disconnection times. The tests had been performed on the SOFAR 3000TL is valid for the SOFAR 1100TL, SOFAR 1600TL, SOFAR 2200TL and SOFAR 2700TL, since it is same as in hardware and just power derated by software.</p>				

25% Power

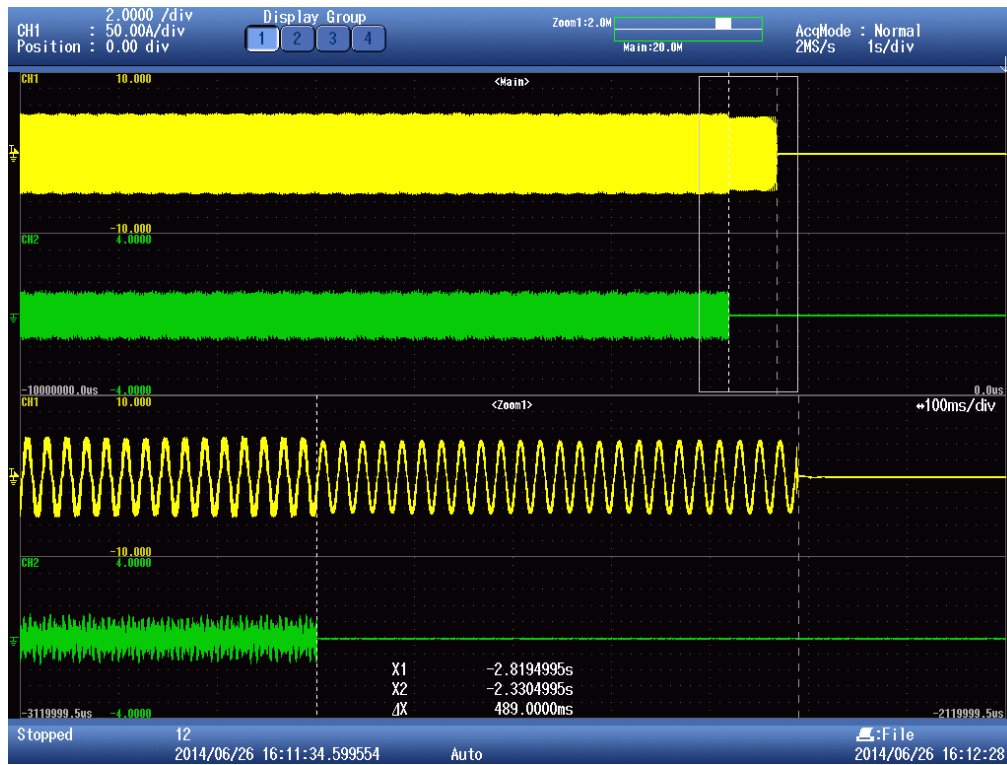

50% Power



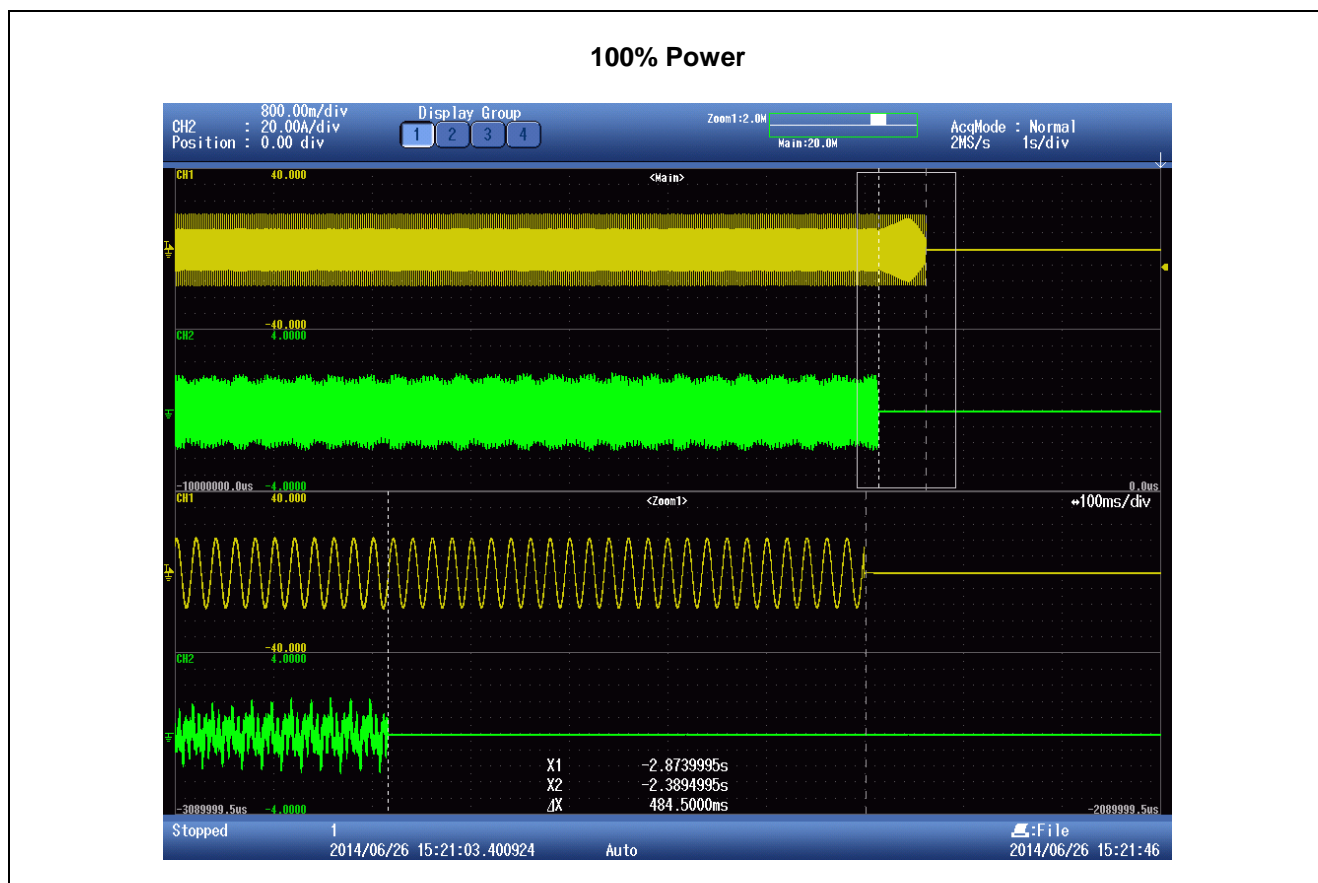

5.1 Harmonic current emission (EN 61000-3-2) (SOFAR 1100TL)				P
Watts [kW]		1,017		
Vrms [V]		230,07		
Arms [A]		4,419		
Frequency [Hz]		50,00		
THD [%]		1,83		
Harmonics	Current Magnitude [A]	% of Fundamental	Phase	Harmonic Current Limits [%]
1st	4,418	--	Single Phase	N/A
2nd	0,002	0,036	Single Phase	1,08
3rd	0,080	1,799	Single Phase	2,3
4th	0,001	0,032	Single Phase	N/A
5th	0,010	0,224	Single Phase	1,14
6th	0,001	0,032	Single Phase	N/A
7th	0,006	0,140	Single Phase	0,77
8th	0,002	0,036	Single Phase	N/A
9th	0,004	0,091	Single Phase	0,4
10th	0,002	0,043	Single Phase	N/A
11th	0,003	0,059	Single Phase	0,33
12th	0,002	0,043	Single Phase	N/A
13th	0,002	0,045	Single Phase	0,21
14th	0,002	0,041	Single Phase	N/A
15th	0,002	0,041	Single Phase	N/A
16th	0,002	0,034	Single Phase	N/A
17th	0,002	0,034	Single Phase	N/A
18th	0,001	0,029	Single Phase	N/A
19th	0,002	0,036	Single Phase	N/A
20th	0,001	0,032	Single Phase	N/A
21th	0,002	0,048	Single Phase	N/A
22th	0,001	0,025	Single Phase	N/A
23th	0,002	0,034	Single Phase	N/A
24th	0,001	0,023	Single Phase	N/A
25th	0,002	0,041	Single Phase	N/A
26th	0,001	0,018	Single Phase	N/A
27th	0,002	0,034	Single Phase	N/A
28th	0,001	0,023	Single Phase	N/A
29th	0,002	0,041	Single Phase	N/A
30th	0,001	0,014	Single Phase	N/A
31th	0,001	0,032	Single Phase	N/A
32th	0,001	0,018	Single Phase	N/A
33th	0,002	0,036	Single Phase	N/A
34th	0,001	0,014	Single Phase	N/A
35th	0,001	0,032	Single Phase	N/A
36th	0,001	0,014	Single Phase	N/A
37th	0,002	0,036	Single Phase	N/A
38th	0,001	0,016	Single Phase	N/A
39th	0,001	0,029	Single Phase	N/A
40th	0,001	0,014	Single Phase	N/A
Note: The tests should be based on the limits of the EN61000-3-2 for less than 16A and on EN 61000-3-12 for more than 16A.				

5.1 Harmonic current emission (EN 61000-3-2) (SOFAR 3000TL)				P
Watts [kW]		2,804		
Vrms [V]		229,99		
Arms [A]		12,189		
Frequency [Hz]		50,00		
THD [%]		1,38		
Harmonics	Current Magnitude [A]	% of Fundamental	Phase	Harmonic Current Limits [%]
1st	12,188	--	Single Phase	N/A
2nd	0,008	0,066	Single Phase	1,08
3rd	0,158	1,296	Single Phase	2,3
4th	0,006	0,051	Single Phase	N/A
5th	0,032	0,259	Single Phase	1,14
6th	0,003	0,025	Single Phase	N/A
7th	0,014	0,113	Single Phase	0,77
8th	0,003	0,025	Single Phase	N/A
9th	0,005	0,044	Single Phase	0,4
10th	0,004	0,034	Single Phase	N/A
11th	0,006	0,048	Single Phase	0,33
12th	0,004	0,030	Single Phase	N/A
13th	0,012	0,099	Single Phase	0,21
14th	0,004	0,033	Single Phase	N/A
15th	0,010	0,084	Single Phase	N/A
16th	0,003	0,026	Single Phase	N/A
17th	0,013	0,106	Single Phase	N/A
18th	0,002	0,020	Single Phase	N/A
19th	0,014	0,113	Single Phase	N/A
20th	0,003	0,021	Single Phase	N/A
21th	0,015	0,120	Single Phase	N/A
22th	0,002	0,015	Single Phase	N/A
23th	0,014	0,112	Single Phase	N/A
24th	0,002	0,013	Single Phase	N/A
25th	0,013	0,109	Single Phase	N/A
26th	0,002	0,016	Single Phase	N/A
27th	0,013	0,107	Single Phase	N/A
28th	0,002	0,014	Single Phase	N/A
29th	0,012	0,098	Single Phase	N/A
30th	0,001	0,011	Single Phase	N/A
31th	0,011	0,088	Single Phase	N/A
32th	0,001	0,010	Single Phase	N/A
33th	0,009	0,077	Single Phase	N/A
34th	0,001	0,010	Single Phase	N/A
35th	0,009	0,075	Single Phase	N/A
36th	0,001	0,009	Single Phase	N/A
37th	0,008	0,065	Single Phase	N/A
38th	0,001	0,011	Single Phase	N/A
39th	0,008	0,063	Single Phase	N/A
40th	0,001	0,010	Single Phase	N/A

Note:
 The tests should be based on the limits of the EN61000-3-2 for less than 16A and on EN 61000-3-12 for more than 16A.
 The tests had been performed on the SOFAR 1100TL and SOFAR 3000TL are valid for the SOFAR 1600TL, SOFAR 2200TL and SOFAR 2700TL, since it is same as in hardware and just power derated by software.

5.1 Voltage fluctuation and flicker				P
Test conditions	Maximum permissible voltage fluctuation (expressed as a percentage of nominal voltage at 100 % power) and flicker as per EN 61000-3-3			
	Starting	Stopping	Running	
Limit	3,3%	3,3%	P _{st} =1,0	P _{It} =0,65
Test value	See below			
SOFAR 1100TL				
No.	dc[%]	dmax[%]	d(t)[ms]	Pst
1	0.00	0.00	0.00	0.07
2	0.00	0.00	0.00	0.07
3	0.00	0.00	0.00	0.07
4	0.00	0.00	0.00	0.07
5	0.00	0.00	0.00	0.07
6	0.00	0.00	0.00	0.07
7	0.00	0.00	0.00	0.07
8	0.00	0.00	0.00	0.07
9	0.00	0.00	0.00	0.07
10	0.00	0.00	0.00	0.07
11	0.00	0.00	0.00	0.07
12	0.00	0.00	0.00	0.07
				P _{It} 0.07
SOFAR 3000TL				
No.	dc[%]	dmax[%]	d(t)[ms]	Pst
1	0.00	0.00	0.00	0.07
2	0.00	0.00	0.00	0.07
3	0.00	0.00	0.00	0.07
4	0.00	0.00	0.00	0.07
5	0.00	0.00	0.00	0.07
6	0.00	0.00	0.00	0.07
7	0.00	0.00	0.00	0.07
8	0.00	0.00	0.00	0.07
9	0.00	0.00	0.00	0.07
10	0.00	0.00	0.00	0.07
11	0.00	0.00	0.00	0.07
12	0.00	0.00	0.00	0.07
				P _{It} 0.07

Note:

*The stationary deviance of $d_c\%$ is bigger than the dynamic deviance of d_{max} at starting and stopping.

Mains Impedance according EN61000-3-3: $R_{max} = 0,24 \Omega$; $jX_{max} = 0,15\Omega @ 50Hz$ ($|Z_{max}| = 0,283\Omega$)
Bei Einphasigen Invertern Z_{max} sowie R_n und jx_n angeben $R_n = 0,16\Omega$; $jX_n = 0,10\Omega$

Calculation of the maximum permissible grid impedance at the point of common coupling based on d_c :
 $Z_{max} = Z_{ref} * 3,3\% / d_c(P_n)$

The tests should be based on the limits of the EN61000-3-3 for less than 16A and on EN 61000-3-11 for more than 16A.

The tests had been performed on the SOFAR 1100TL and SOFAR 3000TL are valid for the SOFAR 1600TL, SOFAR 2200TL and SOFAR 2700TL, since it is same as in hardware and just power derated by software.

5.2 Monitoring of DC-Injection				P
Protection limit	tested at three power levels limit 0,5% of $I_{AC,nom}$			
Output power	~25%	~50%	~100%	
SOFAR 1100TL				
max. test value [mA]	-7 mA	-6 mA	-6 mA	
SOFAR 3000TL				
max. test value [mA]	-9 mA	-9 mA	-8 mA	

Diagram of permanent dc-injection: SOFAR 1100TL

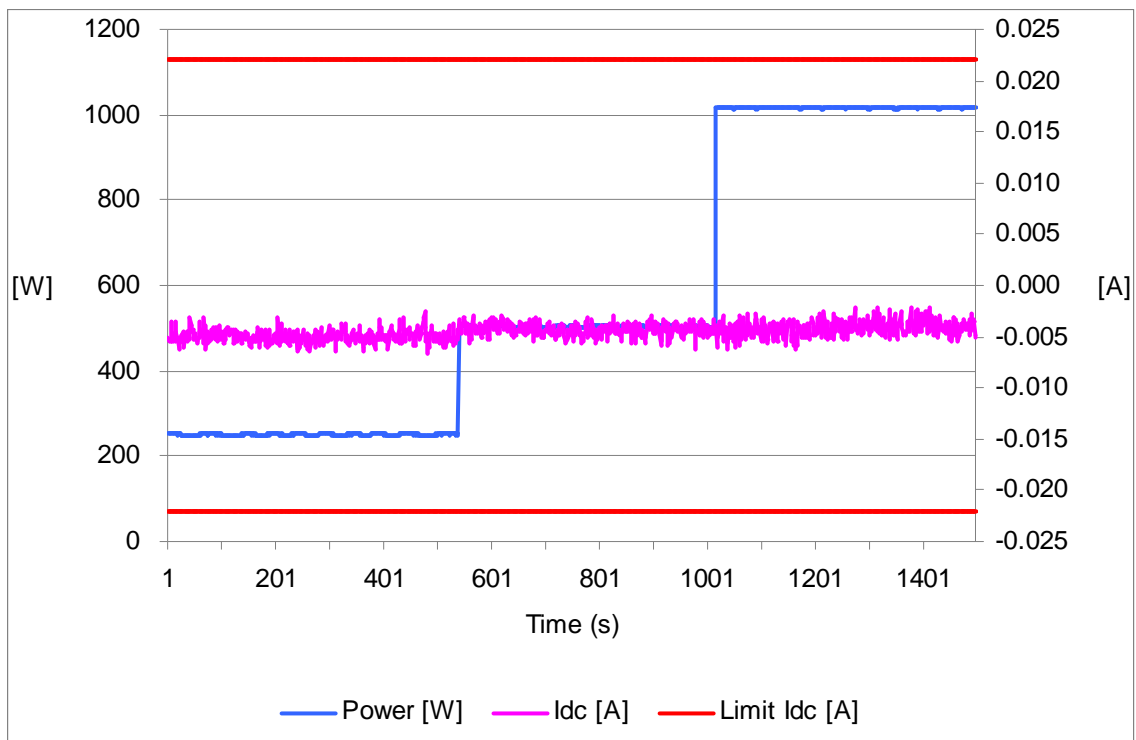
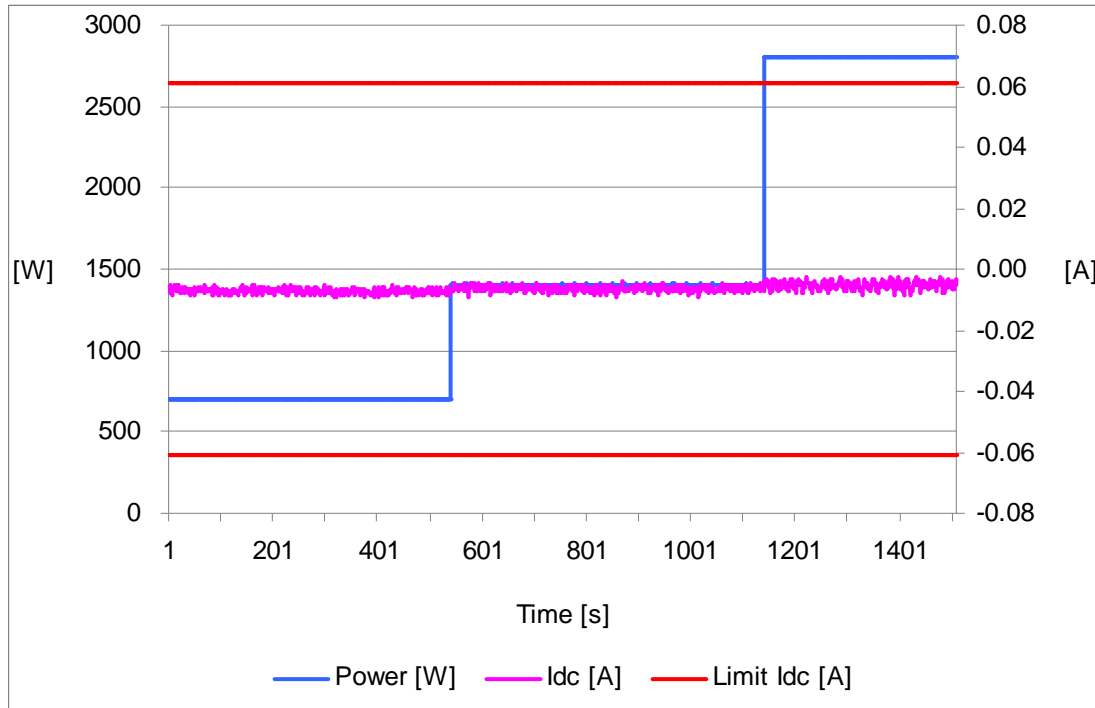

Diagram of permanent dc-injection: SOFAR 3000TL



Note:

Testing must be performed according to WI 10.4.-03.doc rev D. The internal temperature of the EUT must be stabilized. No temperature drift of more than 2K within 1 hour is allowed.

The tests had been performed on the SOFAR 1100TL and SOFAR 3000TL are valid for the SOFAR 1600TL, SOFAR 2200TL and SOFAR 2700TL, since it is same as in hardware and just power derated by software.

5.3 Power factor					P	
SOFAR 1100TL						
Test conditions		U _{input} = 400V				
Output power		~20%	~40%	~60%	~80%	~100%
Test voltage						
210V		0,994c	0,998c	0,999c	0,999c	0,999c
230V		0,991c	0,998c	0,999c	0,999c	0,999c
250V		0,987c	0,997c	0,999c	0,999c	0,999c
SOFAR 3000TL						
Test conditions		U _{input} = 450V				
Output power		~20%	~40%	~60%	~80%	~100%
Test voltage						
210V		0,998c	0,999c	0,999c	0,999c	0,999c
230V		0,998c	0,999c	0,999c	0,999c	0,999c
250V		0,997c	0,999c	0,999c	0,999c	0,999c
Note:						
The power factor of the micro-generator at normal steady-state operating conditions across the statutory tolerance band of normal voltage shall be between 0,95 leading and 0,95 lagging, provided the output active power of the micro-generator is above 20% the rated output of the unit.						
The tests had been performed on the SOFAR 1100TL and SOFAR 3000TL are valid for the SOFAR 1600TL, SOFAR 2200TL and SOFAR 2700TL, since it is same as in hardware and just power derated by software.						

Annex 1

EMC Test Report



ATTESTATION of conformity with European Directives

Attestation Number: 1488AB0508N005R1001
Product: PV Grid Inverter
Brand Name: 
Model: SOFAR 3000TL, SOFAR 1100TL, SOFAR 2200TL
Additional Model: SOFAR 1600TL, SOFAR 2700TL
Applicant: Shenzhen SOFARSOLAR Co., Ltd.
Address: 3A-1, Huake Building, East Technology Park, Qiaoxiang Road, Nanshan District, Shenzhen, China.
Technical Characteristics: DC Input: DC 110 - 380V Max. 10A For SOFAR 1100TL;
DC Input: DC 165 - 380V Max. 10A For SOFAR 1600TL ;
DC Input: DC 170 - 450V Max. 13A For SOFAR 2200TL;
DC Input: DC 210 - 450V Max. 13A For SOFAR 2700TL;
DC Input: DC 230 - 450V Max. 13A For SOFAR 3000TL
Output: AC 230V, 50/60Hz, Power: 1000W / 1500W / 2000W / 2500W / 2800W
Output Voltage/Current: SOFAR 1100TL:230V/4.5A; SOFAR 1600TL:230V/7.0A;
SOFAR 2200TL:230V/9.5A; SOFAR 2700TL:230V/11.5A; SOFAR 3000TL:230V/13.0A

The submitted sample of the above equipment has been tested for CE marking according to following European Directive and standards:

- Electromagnetic Compatibility Directive 2004/108/EC

Standards	Report Number	Report date
EN 61000-6-3:2007 + A1:2011 EN 61000-3-2:2006 + A1 :2009 + A2:2009 EN 61000-3-3:2013 EN 61000-6-2:2005	CE140508N005R1	Jul. 21, 2014

The referred test report(s) show that the product complies with standard(s) recognized as giving presumption of compliance with the essential requirements in the specified European Directive.

This verification does not imply assessment of the production of the product. The CE marking may be affixed if all relevant and effective European Directives with CE are applicable.



Supervisor
EMC Department

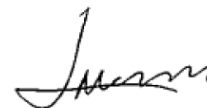

Name: Madison Luo
Date: Jul. 21, 2014

This document shall not be reproduced, except in full, without the written approval of
Bureau Veritas Shenzhen Co., Ltd.

Information given in this document is related to the tested specimen of the described electrical sample.

Bureau Veritas Shenzhen Co., Ltd.
Dongguan Branch

No. 34, Chenwulu Section, Guantai Rd.,
Houjie Town, Dongguan City,
Guangdong 523942, China

Tel.: +86 769 8593 5656
Fax: +86 769 8593 1080
Email: customerservice.dg@cn.bureauveritas.com

Bureau Veritas Shenzhen Co., Ltd.
Dongguan Branch

No. 34, Chenwulu Section, Guantai Rd.,
Houjie Town, Dongguan City, Guangdong
523942, China

Tel: +86 769 8593 5656
Fax: +86 769 8599 1080
Email: customerservice.dg@cn.bureauveritas.com

TEST REPORT

Applicant	Shenzhen SOFARSOLAR Co., Ltd.	
Address	3A-1, Huake Building, East Technology Park, Qiaoxiang Road, Nanshan District, Shenzhen, China.	
Manufacturer or Supplier	Shenzhen SOFARSOLAR Co., Ltd.	
Address	3A-1, Huake Building, East Technology Park, Qiaoxiang Road, Nanshan District, Shenzhen, China.	
Product	PV grid-interactive inverter	
Brand Name		
Model	SOFAR 3000TL, SOFAR 1100TL, SOFAR 2200TL	
Additional Model & Model Difference	SOFAR 1600TL, SOFAR 2700TL See item 2.1	
Date of tests	May 08, 2014 ~ Jun. 30, 2014	
<p>The submitted sample of the above equipment has been tested for according to following European Directive - Electromagnetic directive 2004/108/EC and the tests have been carried out according to the requirements of the following standards:</p> <ul style="list-style-type: none"> <input checked="" type="checkbox"/> EN 61000-6-3:2007 + A1:2011 <input checked="" type="checkbox"/> EN 61000-3-2:2006 + A1:2009 + A2:2009 <input checked="" type="checkbox"/> EN 61000-3-3:2013 <input checked="" type="checkbox"/> EN 61000-6-2:2005 		
<p>CONCLUSION: The submitted sample was found to <u>COMPLY</u> with the test requirement</p>		
<p>Tested by Breeze Jiang Project Engineer / EMC Department</p>		<p>Approved by Madison Luo Manager / EMC Department</p>
		
		<p>Date: Jul. 21, 2014</p>
<p><small>This report is for your exclusive use. Any copying or replication of this report to or for any other person or entity, or use of our name or trademark, is permitted only with our prior written permission. This report sets forth our findings solely with respect to the test samples identified herein. The results set forth in this report are not indicative or representative of the quality or characteristics of the lot from which a test sample was taken or any similar or identical product unless specifically and expressly noted. Our report includes all of the tests requested by you and the results thereof based upon the information that you provided to us. You have 60 days from date of issuance of this report to notify us of any material error or omission caused by our negligence, provided, however, that such notice shall be in writing and shall specifically address the issue you wish to raise. A failure to raise such issue within the prescribed time shall constitute your unqualified acceptance of the completeness of this report, the tests conducted and the correctness of the report contents. Unless specific mention, the uncertainty of measurement has been explicitly taken into account to declare the compliance or non-compliance to the specification</small></p>		

Bureau Veritas Shenzhen Co., Ltd.
Dongguan Branch

No. 34, Chenwulu Section, Guantai Rd., Houjie
Town, Dongguan City,
Guangdong 523942, China

Tel: +86 769 8593 5656
Fax: +86 769 8593 1080
Email: customerservice.dg@cn.bureauveritas.com



Table of Contents

RELEASE CONTROL RECORD	5
1 SUMMARY OF TEST RESULTS	6
1.1 MEASUREMENT UNCERTAINTY	8
2 GENERAL INFORMATION	9
2.1 GENERAL DESCRIPTION OF EUT	9
2.2 DESCRIPTION OF TEST MODES	11
2.3 GENERAL DESCRIPTION OF APPLIED STANDARDS	12
2.4 DESCRIPTION OF SUPPORT UNITS	12
3 EMISSION TEST	13
3.1 CONDUCTED EMISSION MEASUREMENT	13
3.1.1 LIMITS OF CONDUCTED EMISSION MEASUREMENT	13
3.1.2 TEST INSTRUMENTS	13
3.1.3 TEST PROCEDURE	14
3.1.4 DEVIATION FROM TEST STANDARD	14
3.1.5 TEST SETUP	15
3.1.6 EUT OPERATING CONDITIONS	15
3.1.7 TEST RESULTS	16
3.2 RADIATED EMISSION MEASUREMENT	18
3.2.1 LIMITS OF RADIATED EMISSION MEASUREMENT	18
3.2.2 TEST INSTRUMENTS	19
3.2.3 TEST PROCEDURE	20
3.2.4 DEVIATION FROM TEST STANDARD	21
3.2.5 TEST SETUP	22
3.2.6 EUT OPERATING CONDITIONS	22
3.2.7 TEST RESULTS	23
3.3 HARMONICS CURRENT MEASUREMENT (<16A)	25
3.3.1 LIMITS OF HARMONICS CURRENT MEASUREMENT	25
3.3.2 TEST INSTRUMENTS	26
3.3.3 TEST PROCEDURE	26
3.3.4 DEVIATION FROM TEST STANDARD	27
3.3.5 TEST SETUP	27
3.3.6 EUT OPERATING CONDITIONS	27
3.3.7 TEST RESULTS	28
3.4 VOLTAGE FLUCTUATION AND FLICKS MEASUREMENT	32
3.4.1 LIMITS OF VOLTAGE FLUCTUATION AND FLICKS MEASUREMENT	32
3.4.2 TEST INSTRUMENTS	32
3.4.3 TEST PROCEDURE	32
3.4.4 DEVIATION FROM TEST STANDARD	33
3.4.5 TEST SETUP	33
3.4.6 EUT OPERATING CONDITIONS	33
3.4.7 TEST RESULTS	34
4 IMMUNITY TEST	36
4.1 GENERAL DESCRIPTION	36

Bureau Veritas Shenzhen Co., Ltd.
Dongguan Branch

No. 34, Chenwulu Section, Guantai Rd., Houjie
Town, Dongguan City,
Guangdong 523942, China

Tel: +86 769 8593 5656
Fax: +86 769 8593 1080
Email: customerservice.dg@cn.bureauveritas.com



4.1.1	GENERAL DESCRIPTION OF EN 61000-6-2	36
4.1.2	PERFORMANCE CRITERIA	37
4.1.3	EUT OPERATING CONDITION	37
4.2	ELECTROSTATIC DISCHARGE IMMUNITY TEST (ESD)	38
4.2.1	TEST SPECIFICATION	38
4.2.2	TEST INSTRUMENTS	38
4.2.3	TEST PROCEDURE	39
4.2.4	DEVIATION FROM TEST STANDARD	39
4.2.5	TEST SETUP	40
4.2.6	TEST RESULTS	41
4.3	RADIATED, RADIO-FREQUENCY, ELECTROMAGNETIC FIELD IMMUNITY TEST (RS)	42
4.3.1	TEST SPECIFICATION	42
4.3.2	TEST INSTRUMENTS	42
4.3.3	TEST PROCEDURE	43
4.3.4	DEVIATION FROM TEST STANDARD	43
4.3.5	TEST SETUP	44
4.3.6	TEST RESULTS	45
4.4	ELECTRICAL FAST TRANSIENT/BURST IMMUNITY TEST (EFT)	46
4.4.1	TEST SPECIFICATION	46
4.4.2	TEST INSTRUMENTS	46
4.4.3	TEST PROCEDURE	46
4.4.4	DEVIATION FROM TEST STANDARD	46
4.4.5	TEST SETUP	47
4.4.6	TEST RESULTS	48
4.5	SURGE IMMUNITY TEST	49
4.5.1	TEST SPECIFICATION	49
4.5.2	TEST INSTRUMENTS	49
4.5.3	TEST PROCEDURE	50
4.5.4	DEVIATION FROM TEST STANDARD	50
4.5.5	TEST SETUP	50
4.5.6	TEST RESULTS	51
4.6	IMMUNITY TO CONDUCTED DISTURBANCES INDUCED BY RF FIELDS (CS)	52
4.6.1	TEST SPECIFICATION	52
4.6.2	TEST INSTRUMENTS	52
4.6.3	TEST PROCEDURE	53
4.6.4	DEVIATION FROM TEST STANDARD	53
4.6.5	TEST SETUP	54
4.6.6	TEST RESULTS	55
4.7	POWER FREQUENCY MAGNETIC FIELD IMMUNITY TEST	56
4.7.1	TEST SPECIFICATION	56
4.7.2	TEST INSTRUMENTS	56
4.7.3	TEST PROCEDURE	56
4.7.4	DEVIATION FROM TEST STANDARD	56
4.7.5	TEST SETUP	57
4.7.6	TEST RESULTS	58
5	PHOTOGRAPHS OF THE TEST CONFIGURATION	59

Bureau Veritas Shenzhen Co., Ltd.
Dongguan Branch

No. 34, Chenwulu Section, Guantai Rd., Houjie
Town, Dongguan City,
Guangdong 523942, China

Tel: +86 769 8593 5656
Fax: +86 769 8593 1080
Email: customerservice.dg@cn.bureauveritas.com



Test Report No.: CE140508N005R1

6	APPENDIX A – MODIFICATIONS RECORDERS FOR ENGINEERING CHANGES TO THE EUT BY THE LAB	66
---	---	----

Bureau Veritas Shenzhen Co., Ltd.
Dongguan Branch

No. 34, Chenwulu Section, Guantai Rd., Houjie
Town, Dongguan City,
Guangdong 523942, China

Tel: +86 769 8593 5656
Fax: +86 769 8593 1080
Email: customerservice.dg@cn.bureauveritas.com

Bureau Veritas Shenzhen Co., Ltd.
Dongguan Branch

No. 34, Chenwulu Section, Guantai Rd.,
Houjie Town, Dongguan City, Guangdong
523942, China
Page 38 of 127

Tel: +86 769 8593 5656
Fax: +86 769 8599 1080
Email: customerservice.dg@cn.bureauveritas.com
TEST REPORT EN 50438 VER.1

RELEASE CONTROL RECORD

ISSUE NO.	REASON FOR CHANGE	DATE ISSUED
CE140508N005	Original release	Jul. 10, 2014
CE140508N005R1	Based on the original report CE140508N005 change power supply information, model and technical characteristics.	Jul. 21, 2014

Bureau Veritas Shenzhen Co., Ltd.
Dongguan Branch

No. 34, Chenwulu Section, Guantai Rd., Houjie
Town, Dongguan City,
Guangdong 523942, China

Tel: +86 769 8593 5656
Fax: +86 769 8593 1080
Email: customerservice.dg@cn.bureauveritas.com

Page 5 of 66

Report Version 1

Bureau Veritas Shenzhen Co., Ltd.
Dongguan Branch

No. 34, Chenwulu Section, Guantai Rd.,
Houjie Town, Dongguan City, Guangdong
523942, China
Page 39 of 127

Tel: +86 769 8593 5656
Fax: +86 769 8599 1080
Email: customerservice.dg@cn.bureauveritas.com
TEST REPORT EN 50438 VER.1



1 SUMMARY OF TEST RESULTS

The EUT has been tested according to the following specifications:

EMISSION			
Standard	Test Type	Result	Remarks
EN61000-6-3:2007+ A1:2011	Conducted test	PASS	Meets requirement limit Minimum passing margin is -3.00 dB at 0.36094MHz
	Radiated test (30MHz~1GHz)	PASS	Meets limits minimum passing margin is -5.08 dB at 191.02MHz
EN 61000-3-2:2006 + A1:2009 + A2:2009	Harmonic current emissions	PASS	Meets the requirements.
EN 61000-3-3:2013	Voltage fluctuations & flicker	PASS	Meets the requirements.

IMMUNITY (EN 61000-6-2:2005)			
Standard	Test Type	Result	Remarks
IEC 61000-4-2:2008	Electrostatic discharge immunity test	PASS	Electrostatic Discharge – ESD: 8kV Air discharge, 4kV Contact discharge, Performance Criterion A
IEC 61000-4-3:2005 + A1:2007+A2:2010	Radiated, radio-frequency, electromagnetic field immunity test	PASS	Radio-Frequency Electromagnetic Field Susceptibility Test – RS: 80-1000 MHz, 10V/m, 80% AM (1kHz), 1400-2000 MHz, 3V/m, 80% AM (1kHz) 2000-2700 MHz, 1V/m, 80% AM (1kHz) Performance Criterion A
IEC 61000-4-4:2012	Electrical fast transient / burst immunity test.	PASS	Electrical Fast Transient/Burst - EFT AC Power line: 2kV, DC Power line: 2kV, Performance Criterion A
IEC 61000-4-5:2005	Surge immunity test	PASS	Surge Immunity Test: 1.2/50 us Open Circuit Voltage, 8 /20 us Short Circuit Current, AC Power Line: line to line 1 kV, Line to earth 2kV , DC Power Line: line to line 0.5 kV Performance Criterion B
IEC 61000-4-6:2008	Immunity to conducted disturbances, induced by radio-frequency fields	PASS	Conducted Radio Frequency Disturbances Test – CS: 0.15-80 MHz, 10Vrms, 80% AM, 1kHz, Performance Criterion A
IEC 61000-4-8:2009	Power frequency magnetic field immunity test.	PASS	Power Frequency Magnetic Field Test, 50 Hz / 60Hz, 30A/m, Performance Criterion A

1.1 MEASUREMENT UNCERTAINTY

Where relevant, the following measurement uncertainty levels have been estimated for tests performed on the EUT as specified in CISPR 16-4-2:

This uncertainty represents an expanded uncertainty expressed at approximately the 95% confidence level using a coverage factor of $k=2$.

MEASUREMENT	FREQUENCY	UNCERTAINTY
Mains Terminal Disturbance Voltage Test	0.15MHz ~ 30MHz	+/-2.67 dB
Radiated Disturbance Test	30MHz ~ 1000MHz	+/-4.36 dB



BUREAU VERITAS Test Report No.: CE140508N005R1

2 GENERAL INFORMATION

2.1 GENERAL DESCRIPTION OF EUT

PRODUCT	PV Grid Inverter
MODEL NO.	SOFAR 3000TL, SOFAR 1100TL, SOFAR 2200TL
ADDITIONAL MODEL	SOFAR 1600TL, SOFAR 2700TL
POWER SUPPLY	DC Input: DC 110 - 380V Max. 10A For SOFAR 1100TL; DC Input: DC 165 - 380V Max. 10A For SOFAR 1600TL ; DC Input: DC 170 - 450V Max. 13A For SOFAR 2200TL; DC Input: DC 210 - 450V Max. 13A For SOFAR 2700TL; DC Input: DC 230 - 450V Max. 13A For SOFAR 3000TL Output: AC 230V, 50/60Hz, Power: 1000W / 1500W / 2000W / 2500W / 2800W Output Voltage/Current: SOFAR 1100TL:230V/4.5A; SOFAR 1600TL:230V/7.0A; SOFAR 2200TL:230V/9.5A; SOFAR 2700TL:230V/11.5A; SOFAR 3000TL:230V/13.0A
SOFTWARE VERSION	V1.00
HARDWARE VERSION	V1.00
THE HIGHEST OPERATING FREQUENCY	Below 108MHz
DATA CABLE SUPPLIED	DC Cable: Shielded; Detachable 1.8m; AC Cable: Shielded; Detachable 1.8m

NOTE:

1. This report CE140508N005R1 supersedes the previous one with the report number CE140508N005 dated on Jul. 10, 2014.
2. For the test results, the EUT had been tested with all conditions. But only the worst case was showed in test report.
3. For a more detailed features description, please refer to the manufacturer's specifications or the User's Manual.
4. RS485 port on the product is for client to collect data, according to client requirements, no need to test.
5. All models shell include red, blue, white and other colors. All models of DC switch and WIFI module is optional accessories, optional installation according to the need of client.

Bureau Veritas Shenzhen Co., Ltd.
Dongguan Branch

No. 34, Chenwulu Section, Guantai Rd., Houjie
Town, Dongguan City,
Guangdong 523942, China

Tel: +86 769 8593 5656
Fax: +86 769 8593 1080
Email: customerservice.dg@cn.bureauveritas.com

Page 9 of 66

Report Version 1

Bureau Veritas Shenzhen Co., Ltd.
Dongguan Branch

No. 34, Chenwulu Section, Guantai Rd.,
Houjie Town, Dongguan City, Guangdong
523942, China

Page 43 of 127

Tel: +86 769 8593 5656
Fax: +86 769 8599 1080
Email: customerservice.dg@cn.bureauveritas.com

TEST REPORT EN 50438 VER.1

6. This is a series of PV Grid Inverter with the same as in hardware except the amount of BUS capacitor, inverter inductor, Boost and IGBT component and DC switch are different. Identical in software the output power just adjusted by software; models SOFAR 3000TL, SOFAR 1100TL, SOFAR 2200TL are selected to test. full test was performed for the model SOFAR 3000TL, and partial test for the models SOFAR 1100TL, SOFAR 2200TL.

Ratings	SOFAR 1100TL	SOFAR 1600TL	SOFAR 2200TL	SOFAR 2700TL	SOFAR 3000TL
MPP DC voltage range [V]	110-380	165-380	170-450	210-450	230-450
Input DC voltage range [V]	90-400, max. 450		100-480, max. 500		
Input DC current [A]	10		13		
Output AC voltage [V]	230V, 50Hz				
Output AC current [A]	4,5	7,0	9,5	11,5	13,0
Output power [W]	1000	1500	2000	2500	2800

7. Model Difference:

Difference:	SOFAR 3000TL	SOFAR 2700TL	SOFAR 2200TL	SOFAR 1600TL	SOFAR 1100TL
Boost inductor	1.9mH	1.9mH	1.9mH	2.6mH	2.6mH
Input sampling resistor (RP105,RP108 /RP189,RP109)	200ohm / 7.5Kohm	200ohm / 7.5Kohm	200ohm / 7.5Kohm	220ohm / 10Kohm	220ohm / 10Kohm
Bus capacitor	3pcs	3pcs	3pcs	2pcs	2pcs
Inverter inductor	1.3mH	1.5mH	2.1mH	2.3mH	3.4mH
Output sampling resistor (RP118, RP119, RC18 /RP120, RP121,RC22)	2Kohm,100ohm,100ohm	2Kohm,100ohm,100ohm	1.0Kohm,330ohm,330ohm	1.0Kohm,200ohm,100ohm	499ohm,200ohm,200ohm



2.2 DESCRIPTION OF TEST MODES

The EUT was tested under the following modes' the final worst mode were marked in boldface and recorded in this report.

◆ For Conducted Emission Test

Test Mode	TEST VOLTAGE	Model
Full Load	DC 380V	SOFAR 2200TL
Full Load	DC 380V	SOFAR 1100TL
Full Load	DC 230V	SOFAR 3000TL
Full Load	DC 360V	
Full Load	DC 450V	

◆ For Radiated Emission Test

Test Mode	TEST VOLTAGE	Model
Full Load	DC 380V	SOFAR 2200TL
Full Load	DC 380V	SOFAR 1100TL
Full Load	DC 230V	SOFAR 3000TL
Full Load	DC 360V	
Full Load	DC 450V	

◆ For Harmonics and Flicker Tests

Test Mode	TEST VOLTAGE	Model
Full Load	DC 380V	SOFAR 1100TL
Full Load	DC 380V	SOFAR 3000TL

◆ For Immunity Test

Test Mode	TEST VOLTAGE	Model
10% Load	DC 300V	SOFAR 3000TL



2.3 GENERAL DESCRIPTION OF APPLIED STANDARDS

The EUT has been tested and complied with the requirements of the following standards:

EN 61000-6-3:2007 + A1:2011
 EN 61000-3-2:2006 + A1:2009 + A2:2009
 EN 61000-3-3:2013
 EN 61000-6-2:2005
 IEC 61000-4-2:2008
 IEC 61000-4-3:2005 + A1:2007 + A2:2010
 IEC 61000-4-4:2012
 IEC 61000-4-5:2005
 IEC 61000-4-6:2008
 IEC 61000-4-8:2009

Notes: The above IEC basic standards are applied with latest version if customer has no special requirement

2.4 DESCRIPTION OF SUPPORT UNITS

The EUT has been tested as an independent unit together with other necessary accessories or support units. The following support units or accessories were used to form a representative test configuration during the tests.

NO.	PRODUCT	BRAND	MODEL NO.	SERIAL NO.	FCC ID
1	DC Source	Chroma	62150H-1000S	62150EF00488	N/A

NO.	SIGNAL CABLE DESCRIPTION OF THE ABOVE SUPPORT UNITS
1	AC Line: Unshielded, Detachable 2.0m, DC Line: Unshielded, Detachable 2.0m;



3 EMISSION TEST

3.1 CONDUCTED EMISSION MEASUREMENT

3.1.1 LIMITS OF CONDUCTED EMISSION MEASUREMENT

FREQUENCY (MHz)	Class A (dBuV)		Class B (dBuV)	
	Quasi-peak	Average	Quasi-peak	Average
0.15 - 0.5	79	66	66 - 56	56 - 46
0.50 - 5.0	73	60	56	46
5.0 - 30.0	73	60	60	50

- Note:**
- (1) The lower limit shall apply at the transition frequencies.
 - (2) The limit decreases in line with the logarithm of the frequency in the range of 0.15 to 0.50 MHz.
 - (3) All emanations from a class A/B digital device or system, including any network of conductors and apparatus connected thereto, shall not exceed the level of field strengths specified above.

3.1.2 TEST INSTRUMENTS

Equipment	Manufacturer	Model No.	Serial No.	Last Cal.	Next Cal.
EMI Test Receiver	Rohde&Schwarz	ESCS30	100199	May 17,14	May 16,15
Pulse Limiter	Rohde&Schwarz	ESH3-Z2	100168	Oct. 12,13	Oct. 11,14
Artificial Mains Network	Rohde&Schwarz	ESH2-Z5	100071	May 13,14	May 12,15
Test software	ADT	ADT_Cond_V7.3.7	N/A	N/A	N/A

- NOTE:**
1. The calibration interval of the above test instruments is 12 months and the calibrations are traceable to CEPREI/CHINA, GRGT/CHINA and NIM/CHINA.
 2. The test was performed in shielding room 843.



3.1.3 TEST PROCEDURE

- a. The EUT was placed 0.4 meters from the conducting wall of the shielded room with EUT being connected to the power mains through a line impedance stabilization network (LISN). Other support units were connected to the power mains through another LISN. The two LISNs provide 50 Ohm/ 50uH of coupling impedance for the measuring instrument.
- b. Both lines of the power mains connected to the EUT were checked for maximum conducted interference.
- c. The frequency range from 150 kHz to 30 MHz was searched. Emission levels under (Limit – 20dB) were not recorded.

3.1.4 DEVIATION FROM TEST STANDARD

No deviation



BUREAU
VERITAS Test Report No.: CE140508N005R1

3.1.5 TEST SETUP

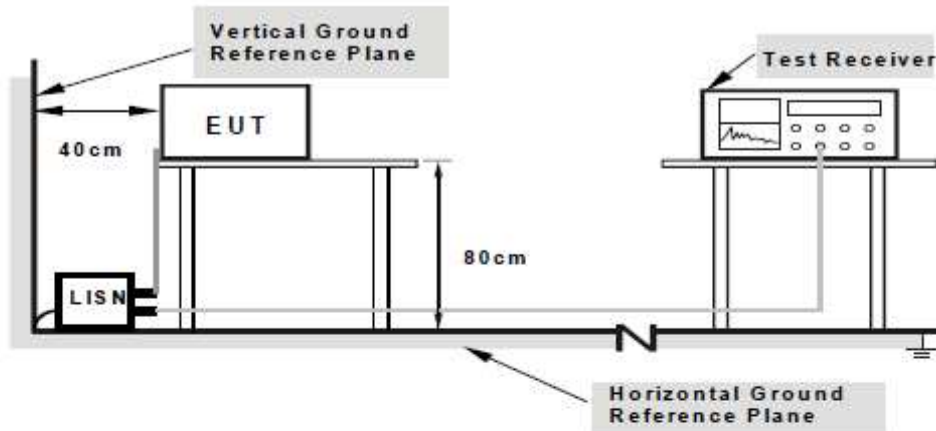

- Note: 1. Support units were connected to second LISN.
2. Both of LISNs (AMN) are 80cm from EUT and at least 80cm from other units and other metal planes support units.

3.1.6 EUT OPERATING CONDITIONS

- Turned on the power of all equipment.
- EUT was operated according to the type description in manufacturer's specifications or the User's Manual.

Bureau Veritas Shenzhen Co., Ltd.
Dongguan Branch

No. 34, Chenwulu Section, Guantai Rd., Houjie
Town, Dongguan City,
Guangdong 523942, China

Tel: +86 769 8593 5656
Fax: +86 769 8593 1080
Email: customerservice.dg@cn.bureauveritas.com

Page 15 of 66

Report Version 1

Bureau Veritas Shenzhen Co., Ltd.
Dongguan Branch

No. 34, Chenwulu Section, Guantai Rd.,
Houjie Town, Dongguan City, Guangdong
523942, China
Page 49 of 127

Tel: +86 769 8593 5656
Fax: +86 769 8599 1080
Email: customerservice.dg@cn.bureauveritas.com
TEST REPORT EN 50438 VER.1



BUREAU VERITAS Test Report No.: CE140508N005R1

3.1.7 TEST RESULTS

TEST MODE	SOFAR 3000TL Grid Mode	6dB BANDWIDTH	9 kHz
TEST VOLTAGE	DC 360V	PHASE	Line (L)
ENVIRONMENTAL CONDITIONS	23 deg. C, 42% RH	TESTED BY: Heise	

No	Freq. [MHz]	Corr. Factor (dB)	Reading Value [dB (uV)]		Emission Level [dB (uV)]		Limit [dB (uV)]		Margin (dB)	
			Q.P.	AV.	Q.P.	AV.	Q.P.	AV.	Q.P.	AV.
1	0.16172	5.20	48.57	45.49	53.77	50.69	65.38	55.38	-11.60	-4.68
2	0.27891	9.16	40.76	37.52	49.92	46.68	60.85	50.85	-10.93	-4.17
3	0.31797	9.23	39.58	36.34	48.81	45.57	59.76	49.76	-10.95	-4.19
4	0.36094	9.32	39.63	36.39	48.95	45.71	58.71	48.71	-9.76	-3.00
5	0.43906	9.47	36.61	34.20	46.08	43.67	57.08	47.08	-11.00	-3.41
6	4.25000	10.01	32.52	25.58	42.53	35.59	56.00	46.00	-13.47	-10.41

REMARKS: The emission levels of other frequencies were very low against the limit.

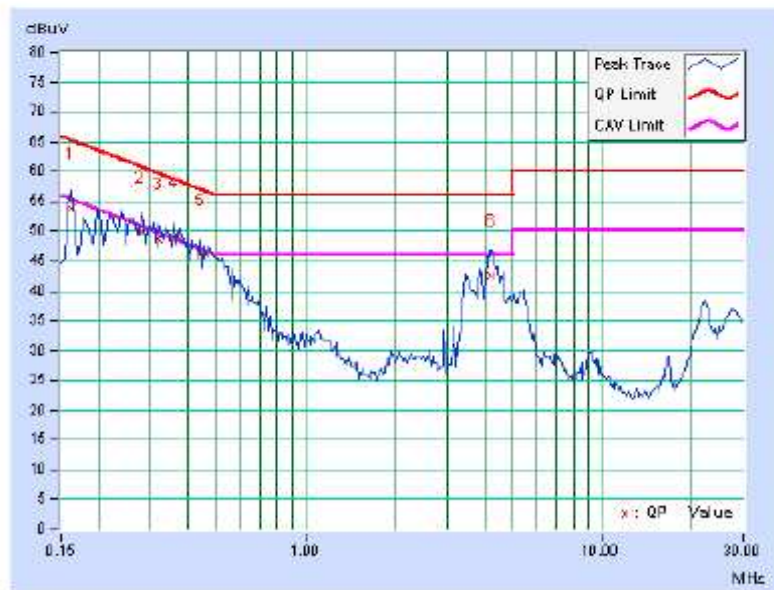

Bureau Veritas Shenzhen Co., Ltd.
Dongguan Branch

No. 34, Chenwulu Section, Guantai Rd., Houjie
Town, Dongguan City,
Guangdong 523942, China

Tel: +86 769 8593 5656
Fax: +86 769 8593 1080
Email: customerservice.dg@cn.bureauveritas.com

Page 16 of 66

Report Version 1

Bureau Veritas Shenzhen Co., Ltd.
Dongguan Branch

No. 34, Chenwulu Section, Guantai Rd.,
Houjie Town, Dongguan City, Guangdong
523942, China
Page 50 of 127

Tel: +86 769 8593 5656
Fax: +86 769 8599 1080
Email: customerservice.dg@cn.bureauveritas.com
TEST REPORT EN 50438 VER.1

TEST MODE	SOFAR 3000TL Grid Mode	6dB BANDWIDTH	9 kHz
TEST VOLTAGE	DC 360V	PHASE	Neutral (N)
ENVIRONMENTAL CONDITIONS	23 deg. C, 42% RH	TESTED BY: Heise	

No	Freq. [MHz]	Corr. Factor (dB)	Reading Value [dB (uV)]		Emission Level [dB (uV)]		Limit [dB (uV)]		Margin (dB)	
			Q.P.	AV.	Q.P.	AV.	Q.P.	AV.	Q.P.	AV.
			1	0.15781	4.85	47.50	43.90	52.35	48.75	65.58
2	0.28281	9.19	39.88	36.67	49.07	45.86	60.73	50.73	-11.67	-4.88
3	0.37656	9.35	38.15	35.11	47.50	44.46	58.35	48.35	-10.85	-3.89
4	0.43906	9.46	36.24	33.89	45.70	43.35	57.08	47.08	-11.38	-3.73
5	0.48203	9.54	35.42	33.03	44.96	42.57	56.30	46.30	-11.35	-3.74
6	4.22266	10.05	33.58	25.62	43.63	35.67	56.00	46.00	-12.37	-10.33

REMARKS: The emission levels of other frequencies were very low against the limit.

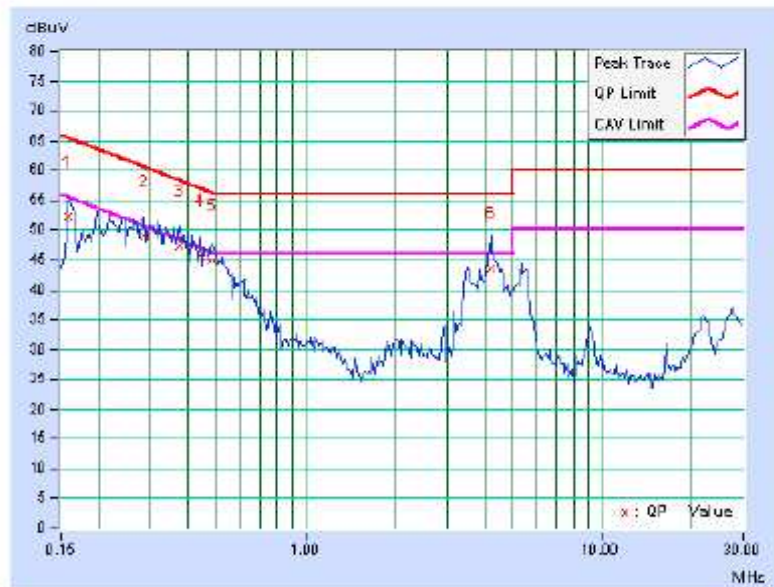



**BUREAU
VERITAS** Test Report No.: CE140508N005R1

3.2 RADIATED EMISSION MEASUREMENT

3.2.1 LIMITS OF RADIATED EMISSION MEASUREMENT

TEST STANDARD: EN 61000-6-3

FOR FREQUENCY BELOW 1000 MHz

FREQUENCY (MHz)	Class A (at 10m)	Class B (at 10m)
	dBuV/m	dBuV/m
30 – 230	40	30
230 – 1000	47	37

FREQUENCY RANGE OF RADIATED MEASUREMENT (For unintentional radiators)

Highest frequency generated or Upper frequency of measurement used in the device or on which the device operates or tunes (MHz)	Range (MHz)
Below 108	1000
108 – 500	2000
500 – 1000	5000
Above 1000	Up to 5 times of the highest frequency or 6 GHz, whichever is less

FOR FREQUENCY ABOVE 1000 MHz

FREQUENCY (GHz)	Class A (dBuV/m) (at 3m)		Class B (dBuV/m) (at 3m)	
	PEAK	AVERAGE	PEAK	AVERAGE
1 to 3	76	56	70	50
3 to 6	80	60	74	54

- NOTE:** (1) The lower limit shall apply at the transition frequencies.
 (2) Emission level (dBuV/m) = 20 log Emission level (uV/m).
 (3) All emanation from a class A/B digital device or system, including any network of conductors and apparatus connected thereto, shall not exceed the level of field strengths specified above.

Bureau Veritas Shenzhen Co., Ltd.
Dongguan Branch

No. 34, Chenwulu Section, Guantai Rd., Houjie Town, Dongguan City, Guangdong 523942, China

Tel: +86 769 8593 5656
Fax: +86 769 8593 1080
Email: customerservice.dg@cn.bureauveritas.com

Page 18 of 66

Report Version 1

Bureau Veritas Shenzhen Co., Ltd.
Dongguan Branch

No. 34, Chenwulu Section, Guantai Rd., Houjie Town, Dongguan City, Guangdong 523942, China
Page 52 of 127

Tel: +86 769 8593 5656
Fax: +86 769 8599 1080
Email: customerservice.dg@cn.bureauveritas.com
TEST REPORT EN 50438 VER.1



3.2.2 TEST INSTRUMENTS

Frequency Range 30MHz-1GHz

Equipment	Manufacturer	Model No.	Serial No.	Last Cal.	Next Cal.
EMI Test Receiver	Rohde&Schwarz	ESCI	100962	Mar. 06,14	Mar. 05,15
Bilog Antenna	Teseq	CBL 6111D	27089	Jul. 27, 13	Jul. 26, 14
Trilog-Broadband Antenna	SCHWARZBECK	VULB 9168	9168-554	Dec. 03, 13	Dec. 02, 14
Trilog-Broadband Antenna	SCHWARZBECK	VULB 9168	9168-555	Dec. 03, 13	Dec. 02, 14
10m Semi-anechoic Chamber	CHANGLING	21.4m*12.1m*8.8m	NSEMC006	Jun. 11, 13	Jun. 10, 14
Amplifier (9kHz-1GHz)	SONOMA	310D	186955	Mar. 05,14	Mar. 04, 15
Test Software	ADT	ADT_Radiated_V7.6.15.9.2	N/A	N/A	N/A

Frequency Range Above1GHz

Equipment	Manufacturer	Model No.	Serial No.	Last Cal.	Next Cal.
Horn Antenna	ETS-Lindgren	3117	00062558	Oct. 18,12	Oct. 17, 14
EMI Test Receiver	Rohde&Schwarz	ESCI	100962	Mar. 06,14	Mar. 05,15
Spectrum Analyzer	Rohde&Schwarz	FSV40	101003	Apr. 09,14	Apr. 08,15
Pre-Amplifier (100MHz-26.5GHz)	EMCI	EMC 012645	980077	Nov. 07,13	Nov. 06,14
Pre-Amplifier (18GHz-40GHz)	EMCI	EMC 184045	980102	Nov. 04,13	Nov. 03,14
Test Software	ADT	ADT_Radiated_V7.6.15.9.2	N/A	N/A	N/A

- NOTE: 1. The calibration interval of the above test instruments is 12 months. And the calibrations are traceable to CEPREI/CHINA and NIM/CHINA.
2. The test was performed in Chamber 10m.



3.2.3 TEST PROCEDURE

<Frequency Range below 1GHz>

- a. The EUT was placed on the top of a rotating table 0.8 meters above the ground at a 10 meter chamber room. The table was rotated 360 degrees to determine the position of the highest radiation.
- b. The EUT was set 10 meters away from the interference-receiving antenna, which was mounted on the top of a variable-height antenna tower.
- c. The height of antenna is varied from one meter to four meters above the ground to determine the maximum value of the field strength. Both horizontal and vertical polarizations of the antenna are set to make the measurement.
- d. For each suspected emission, the EUT was arranged to its worst case and then the antenna was tuned to heights from 1 meter to 4 meters and the turn table was turned from 0 degrees to 360 degrees to find the maximum reading.
- e. The test-receiver system was set to quasi-peak detect function and specified bandwidth with maximum hold mode when the test frequency is below 1 GHz.

NOTE:

1. The resolution bandwidth of test receiver/spectrum analyzer is 120kHz for Quasi-peak detection (QP) at frequency below 1GHz.
2. Emission level(dBuV/m)=Raw Value(dBuV) + Correction Factor(dB/m)
3. Correction Factor(dB/m) = Antenna Factor (dB/m) + Cable Factor (dB)
4. Margin value = Emission level – Limit value.



<Frequency Range above 1GHz>

- a. The EUT was placed on the top of a rotating table 0.8 meters above the ground at a 10 meter Semi-anechoic chamber room. The table was rotated 360 degrees to determine the position of the highest radiation.
- b. The EUT was set 3 meters away from the interference-receiving antenna, which was mounted on the top of a variable-height antenna tower.
- c. The height of antenna can be varied from one meter to four meters, the height of adjustment depends on the EUT height and the antenna 3dB beamwidth both, to detect the maximum value of the field strength. Both horizontal and vertical polarizations of the antenna are set to make the measurement.
- d. For each suspected emission, the EUT was arranged to its worst case and then the antenna was tuned to heights and the rotatable table was turned from 0 degrees to 360 degrees to find the maximum reading.
- e. The test receiver/spectrum was set to peak and average detect function and specified bandwidth with maximum hold mode when the test frequency is above 1 GHz.

NOTE:

1. The resolution bandwidth is 1MHz and video bandwidth of test receiver/spectrum analyzer is 3MHz for Peak detection at frequency above 1GHz. The resolution bandwidth of test receiver/spectrum analyzer is 1 MHz for Average detection (AV) at frequency above 1GHz.
2. For measurement of frequency above 1000 MHz, the EUT was set 3 meters away from the receiver antenna.

3.2.4 DEVIATION FROM TEST STANDARD

No deviation

3.2.5 TEST SETUP

<Frequency Range below 1GHz>

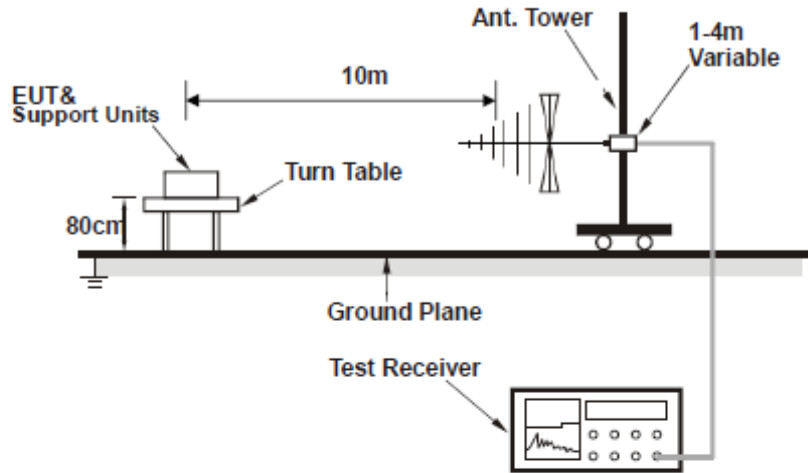

<Frequency Range above 1GHz>

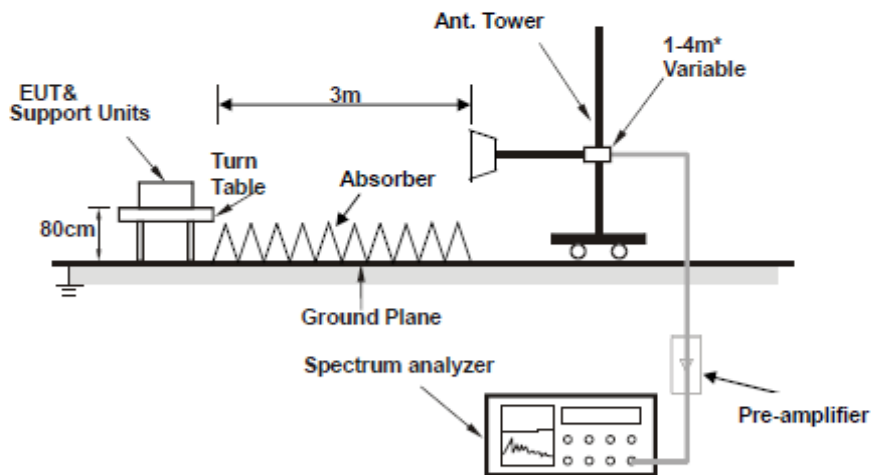

* : depends on the EUT height and the antenna 3dB beamwidth both, refer to section 7.3 of CISPR 16-2-3.

3.2.6 EUT OPERATING CONDITIONS

Same as item 3.1.6



BUREAU VERITAS Test Report No.: CE140508N005R1

3.2.7 TEST RESULTS

TEST MODE	SOFAR 3000TL Grid Mode	FREQUENCY RANGE	30-1000 MHz
TEST VOLTAGE	DC 360V	DETECTOR FUNCTION & BANDWIDTH	Quasi-Peak, 120kHz
ENVIRONMENTAL CONDITIONS	25 deg. C, 50% RH	TESTED BY: Robert	

ANTENNA POLARITY & TEST DISTANCE: HORIZONTAL AT 10 M								
No.	Freq. (MHz)	Correction Factor (dB/m)	Raw Value (dBuV)	Emission Level (dBuV/m)	Limit (dBuV/m)	Margin (dB)	Antenna Height (cm)	Table Angle (Degree)
1	43.58	14.96	-0.74	14.22	30.00	-15.78	143	12
2	92.08	10.26	9.47	19.73	30.00	-10.27	400	31
3	113.42	12.35	9.75	22.10	30.00	-7.90	400	313
4	130.88	13.26	11.50	24.76	30.00	-5.24	400	122
5	183.26	12.88	6.59	19.47	30.00	-10.53	219	132
6	247.28	14.09	5.71	19.80	37.00	-17.20	100	13

REMARKS: The emission levels of other frequencies were very low against the limit..

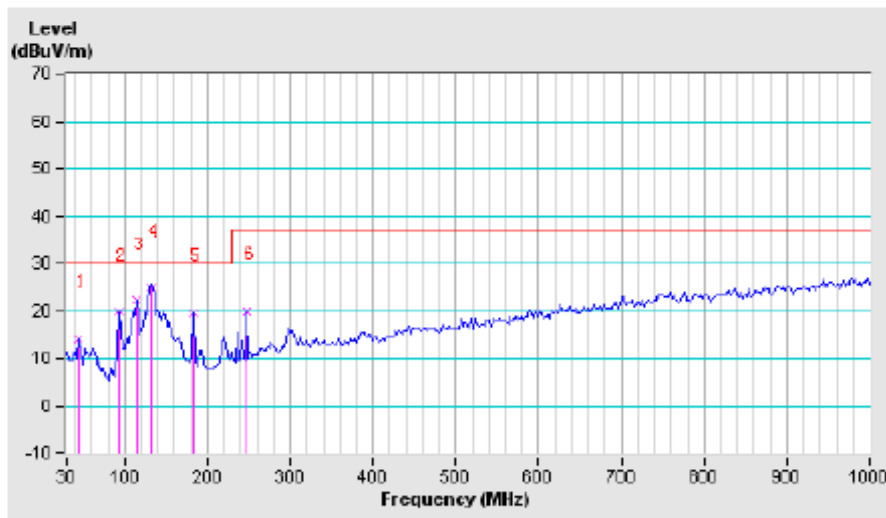

Bureau Veritas Shenzhen Co., Ltd.
Dongguan Branch

No. 34, Chenwulu Section, Guantai Rd., Houjie
Town, Dongguan City,
Guangdong 523942, China

Tel: +86 769 8593 5656
Fax: +86 769 8593 1080
Email: customerservice.dg@cn.bureauveritas.com

Page 23 of 66

Report Version 1

Bureau Veritas Shenzhen Co., Ltd.
Dongguan Branch

No. 34, Chenwulu Section, Guantai Rd.,
Houjie Town, Dongguan City, Guangdong
523942, China
Page 57 of 127

Tel: +86 769 8593 5656
Fax: +86 769 8599 1080
Email: customerservice.dg@cn.bureauveritas.com
TEST REPORT EN 50438 VER.1



TEST MODE	SOFAR 3000TL Grid Mode	FREQUENCY RANGE	30-1000 MHz
TEST VOLTAGE	DC 360V	DETECTOR FUNCTION & BANDWIDTH	Quasi-Peak, 120kHz
ENVIRONMENTAL CONDITIONS	25 deg. C, 50% RH	TESTED BY: Robert	

ANTENNA POLARITY & TEST DISTANCE: VERTICAL AT 10 M								
No.	Freq. (MHz)	Correction Factor (dB/m)	Raw Value (dBuV)	Emission Level (dBuV/m)	Limit (dBuV/m)	Margin (dB)	Antenna Height (cm)	Table Angle (Degree)
1	43.58	14.96	9.04	24.00	30.00	-6.00	195	129
2	61.04	13.28	9.31	22.59	30.00	-7.41	165	104
3	94.00	10.50	12.90	23.40	30.00	-6.60	100	20
4	130.88	13.26	6.84	20.10	30.00	-9.90	100	20
5	191.02	12.37	12.55	24.92	30.00	-5.08	128	72
6	220.12	12.64	8.38	21.02	30.00	-8.98	231	160

REMARKS: The emission levels of other frequencies were very low against the limit.

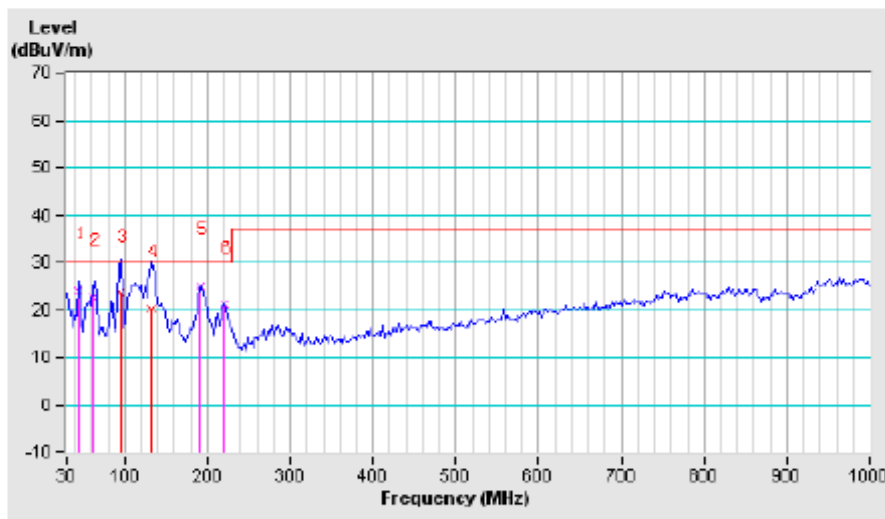



3.3 HARMONICS CURRENT MEASUREMENT (<16A)

3.3.1 LIMITS OF HARMONICS CURRENT MEASUREMENT

TEST STANDARD: EN 61000-3-2

Limits for Class A equipment		Limits for Class D equipment		
Harmonic Order n	Max. permissible harmonics current A	Harmonic Order n	Max. permissible harmonics current per watt mA/W	Max. permissible harmonics current A
Odd harmonics		Odd Harmonics only		
3	2.30	3	3.4	2.30
5	1.14	5	1.9	1.14
7	0.77	7	1.0	0.77
9	0.40	9	0.5	0.40
11	0.33	11	0.35	0.33
13	0.21	13	0.30	0.21
15<=n<=39	0.15x15/n	15<=n<=39	3.85/n	0.15x15/n
Even harmonics				
2	1.08			
4	0.43			
6	0.30			
8<=n<=40	0.23x8/n			

NOTE: 1. Class A and Class D are classified according to section 5 of EN 61000-3-2.

2. According to section 7 of EN 61000-3-2, the above limits for all equipment except for lighting equipment having an active power input > 75 W and no limits apply for equipment with an active power input up to and including 75 W.

◆ **Limits for Class B equipment:**

For class B equipment, the harmonics of the input current shall not exceed the maximum permissible values given for class A equipment multiplied by a factor of 1.5.

Limits for Class C equipment	
Harmonic Order n	Max. permissible harmonics current expressed as a percentage of the input current at the fundamental frequency %
2	2
3	30 · λ
5	10
7	7
9	5
11<=n<=39 (odd harmonics only)	3
λ is the circuit power factor	

NOTE: Discharge lighting equipment having an active TEST VOLTAGE smaller than or equal to 25W, the harmonic currents shall not exceed the power related limits of Class D.



3.3.2 TEST INSTRUMENTS

DESCRIPTION & MANUFACTURER	MANUFACTURER	MODEL NO.	SERIAL NO.	CALIBRATED DATE	CALIBRATED UNTIL
PRECISION POWER ANALYZER	YOKOGAWA	WT3000	91M210852	Mar. 12,14	Mar. 11,15
Test Software	YOKOGAWA	IEC61000	N/A	N/A	N/A
REFERENCE IMPEDANCE NETWORK	Voltech	EUR	3018	N/A	N/A

NOTE: 1. The test was performed in PV Room.

2. The calibration interval of the above test instruments is 12 months and the calibrations are traceable to CEPREI/CHINA, GRGT/CHINA and NIM/CHINA.

3.3.3 TEST PROCEDURE

- a. The EUT was placed on the top of a wooden table 0.8 meters above the ground and operated to produce the maximum harmonic components under normal operating conditions for each successive harmonic component in turn.
- b. The classification of EUT is according to section 5 of EN 61000-3-2:2006 + A1:2009 + A2:2009.

The EUT is classified as follows:

Class A: Balanced three-phase equipment, Household appliances excluding equipment as Class D, Tools excluding portable tools, Dimmers for incandescent lamps, audio equipment, equipment not specified in one of the three other classes.

Class B: Portable tools. ; Arc welding equipment which is not professional equipment

Class C: Lighting equipment.

Class D: Equipment having a specified power less than or equal to 600 W of the following types: Personal computers and personal computer monitors and television receivers.

- c. The correspondent test program of test instrument to measure the current harmonics emanated from EUT is chosen. The measure time shall be not less than the time necessary for the EUT to be exercised.



3.3.4 DEVIATION FROM TEST STANDARD

No deviation

3.3.5 TEST SETUP

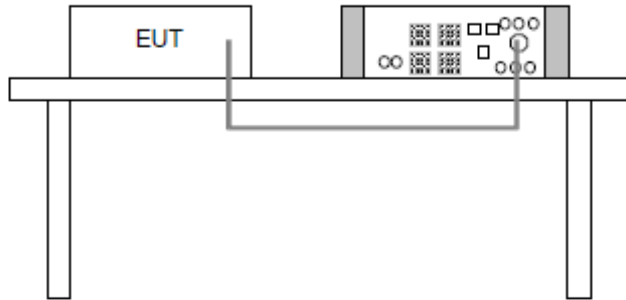

3.3.6 EUT OPERATING CONDITIONS

Same as item 3.1.6



BUREAU VERITAS

Test Report No.: CE140508N005R1

3.3.7 TEST RESULTS

SOFAR 1100TL

***** appliances (Average)

Print Date : Mon May 26 14:15:38 2014
 MeasureDate : Mon May 26 14:15:34 2014
 Comment : Experimental model Pattern A

Regulation : IEC61000-3-2 Ed3.0 am2
 IEC61000-4-7 Ed2.0 A1
 Class : CLASS A
 MeasureTime : 150.00sec
 Model : YOKOGAWA WT3000
 Rating Voltage : 230.00 V
 Wiring : single-phase 2-wire
 Element : 1
 Range : 300V/30A
 Current(rms) : 4.2800 A
 Voltage(rms) : 230.42 V
 Frequency : 50.000 Hz
 Power Factor : 0.9957
 POHC Limit : 0.2514 A
 POHC Max : 0.0040 A
 THC : 0.0958 A

PASS

Set Fundamental I : -----
 Set Power Factor : -----
 Set P : -----
 Sigma W Max : 852.9105 W
 Sigma PF : 0.9957
 Distortion factor(V) : 0.05 %
 V THDS : 0.05 %
 V THDG : 0.05 %
 Distortion factor(A) : 1.53 %
 A THDS : 1.53 %
 A THDG : 1.64 %
 P THD : 0.00 %
 Power Limit : 75 W

Order	Measure[A]	Limit[A]	Margin[%]	Order	Measure[A]	Limit[A]	Margin[%]
1	4.2796			2	0.0036	1.0000	99.1
3	0.0832	2.3000	97.3	4	0.0045	0.4300	99.0
5	0.0596	1.1400	99.2	6	0.0031	0.3000	99.0
7	0.0494	0.7700	99.2	8	0.0022	0.2300	99.0
9	0.0338	0.4000	99.1	10	0.0023	0.1840	99.8
11	0.0023	0.3300	99.4	12	0.0023	0.1533	99.5
13	0.0018	0.2100	99.1	14	0.0018	0.1314	99.6
15	0.0018	0.1500	99.0	16	0.0018	0.1150	99.6
17	0.0014	0.1324	99.0	18	0.0018	0.1022	99.3
19	0.0015	0.1184	99.8	20	0.0018	0.0920	99.3
21	0.0017	0.1071	99.4	22	0.0013	0.0836	99.4
23	0.0014	0.0978	99.6	24	0.0012	0.0767	99.4
25	0.0015	0.0900	99.3	26	0.0014	0.0708	99.0
27	0.0012	0.0833	99.6	28	0.0011	0.0657	99.3
29	0.0012	0.0776	99.5	30	0.0010	0.0513	99.4
31	0.0016	0.0728	99.7	32	0.0011	0.0575	99.1
33	0.0011	0.0682	99.4	34	0.0013	0.0541	97.6
35	0.0011	0.0543	99.3	36	0.0012	0.0511	97.7
37	0.0008	0.0508	99.5	38	0.0012	0.0484	97.8
39	0.0008	0.0577	99.5	40	0.0015	0.0460	96.9

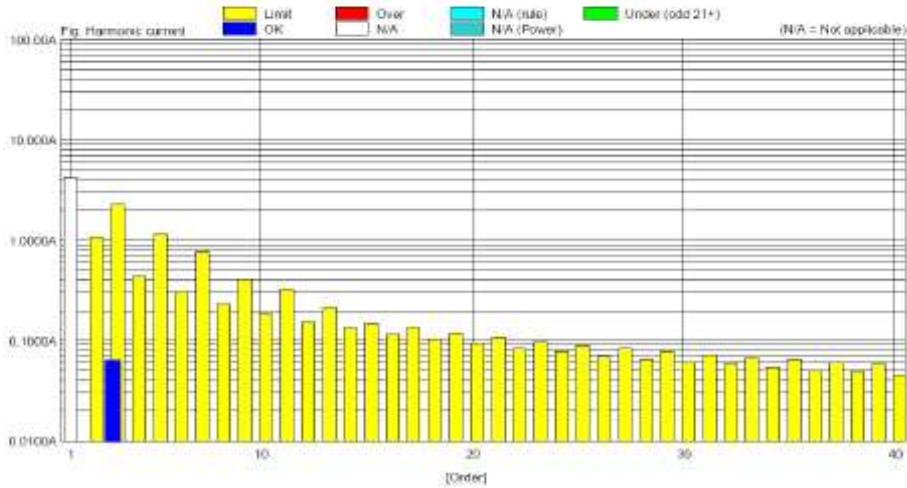

Bureau Veritas Shenzhen Co., Ltd.
 Dongguan Branch

No. 34, Chenwulu Section, Guantai Rd., Houjie
 Town, Dongguan City,
 Guangdong 523942, China

Tel: +86 769 8593 5656
 Fax: +86 769 8593 1080
 Email: customerservice.dg@cn.bureauveritas.com



Test Report No.: CE140508N005R1

***** appliances (Maximum)

Print Date : Mon May 26 14:15:38 2014
 MeasureDate : Mon May 26 14:15:34 2014
 Comment : Experimental model Pattern A

Regulation : IEC61008-3-2 Ed3.0 en2
 IEC61008-4-7 Ed2.0 A1
 Class : CLASS A
 MeasureTime : 150.00sec
 Model : YOKOGAWA WT3000
 Rating Voltage : 230.00 V
 Wiring : single-phase 2-wire
 Element : 1
 Range : 300V/30A
 Current(rms) : 4.2840 A
 Voltage(rms) : 230.42 V
 Frequency : 50.004 Hz
 Power Factor : 0.9957
 Beyond Limit Time : 15.0000 s
 Beyond Total Time : 0.0000 s
 THC : 0.0661 A

PASS

Set Fundamental I : -----
 Set Power Factor : -----
 Set P : -----
 Sigma W Max : 982.9105 W
 Sigma PF : 0.9957
 Distortion factor(V) : 0.05 %
 V THDS : 0.05 %
 V THDG : 0.05 %
 Distortion factor(A) : 1.55 %
 A THDS : 1.55 %
 A THDG : 1.56 %
 P THD : 0.00 %
 Power Limit : 75 W

Order	Measure[A]	Limit[A]	Margin[%]	Order	Measure[A]	Limit[A]	Margin[%]
1	4.2835			2	0.0100	1.6200	99.4
3	0.0635	3.4500	98.2	4	0.0047	0.8450	99.3
5	0.0389	1.7100	99.4	6	0.0033	0.4500	99.3
7	0.0350	1.1550	99.5	8	0.0024	0.3450	99.3
9	0.0325	0.8000	99.4	10	0.0025	0.2760	99.1
11	0.0322	0.4950	99.5	12	0.0025	0.2300	98.9
13	0.0321	0.3150	99.3	14	0.0022	0.1871	99.0
15	0.0315	0.2250	99.3	16	0.0019	0.1725	99.0
17	0.0315	0.1985	99.2	18	0.0019	0.1633	98.8
19	0.0316	0.1776	99.1	20	0.0017	0.1380	98.7
21	0.0319	0.1507	98.8	22	0.0015	0.1255	98.8
23	0.0316	0.1457	98.9	24	0.0015	0.1150	98.8
25	0.0316	0.1350	98.8	26	0.0015	0.1062	98.8
27	0.0313	0.1250	98.9	28	0.0012	0.0985	98.8
29	0.0313	0.1184	98.9	30	0.0010	0.0820	98.9
31	0.0311	0.1089	99.0	32	0.0012	0.0662	98.9
33	0.0313	0.1023	98.8	34	0.0014	0.0812	98.3
35	0.0312	0.0964	98.7	36	0.0013	0.0767	98.4
37	0.0310	0.0912	98.9	38	0.0013	0.0725	98.3
39	0.0310	0.0865	98.9	40	0.0018	0.0690	97.7

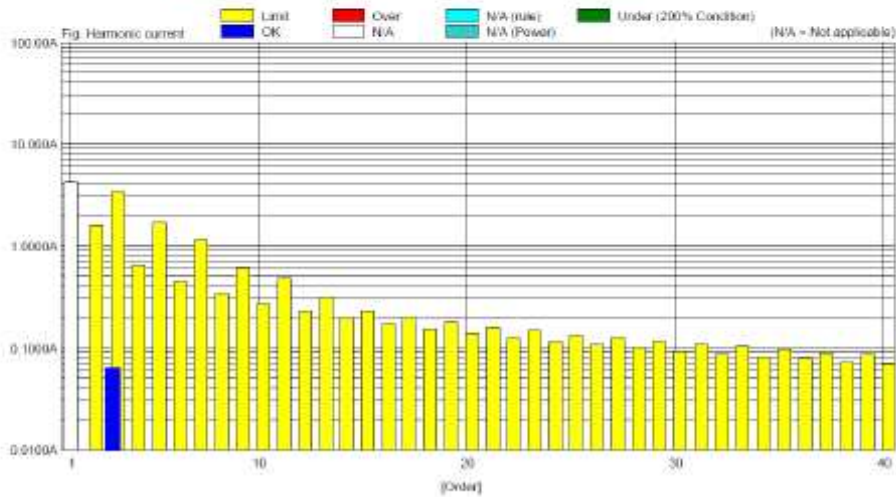

Bureau Veritas Shenzhen Co., Ltd.
 Dongguan Branch

No. 34, Chenwulu Section, Guantai Rd., Houjie
 Town, Dongguan City,
 Guangdong 523942, China

Tel: +86 769 8593 5656
 Fax: +86 769 8593 1080
 Email: customerservice.dg@cn.bureauveritas.com



BUREAU VERITAS

Test Report No.: CE140508N005R1

SOFAR 3000TL

***** appliances (Average)

Print Date: Wed Jun 11 11:32:38 2014
 MeasureDate: Wed Jun 11 11:31:38 2014
 Comment: Experimental model Pattern A

Regulation: IEC81000-3-2 E43 0 am2
 IEC81000-4-7 E42 0 A1
 Class: CLASS A
 MeasureTime: 150.00sec
 Model: YOKOGAWA WT3000
 Rating Voltage: 230.00 V
 Wiring: single-phase 2-wire
 Element: 2
 Range: 300V/30A
 Current(rms): 12.1893 A
 Voltage(rms): 229.89 V
 Frequency: 49.999 Hz
 Power Factor: 0.9988
 PDHC Limit: 0.2514 A
 PDHC Max: 0.0365 A
 THC: 0.1683 A

PASS

Set Fundamental I: -----
 Set Power Factor: -----
 Set P: -----
 Sigma VV Max: 2804.014 W
 Sigma PF: 0.9988
 Distortion factor(V): 0.04 %
 V THDS: 0.04 %
 V THDG: 0.04 %
 Distortion factor(A): 1.38 %
 A THDS: 1.38 %
 A THDG: 1.38 %
 P THD: 0.00 %
 Power Limit: 75 W

Order	Measure[A]	Limit[A]	Margin[%]	Order	Measure[A]	Limit[A]	Margin[%]
1	12.1893			2	0.0091	1.0800	99.2
3	0.1680	2.3000	93.1	4	0.0062	0.4300	98.6
5	0.0310	1.1400	97.2	6	0.0031	0.3000	99.0
7	0.0138	0.7700	98.2	8	0.0031	0.2300	98.7
9	0.0054	0.4000	98.6	10	0.0040	0.1840	97.7
11	0.0009	0.3300	98.2	12	0.0037	0.1533	97.6
13	0.0121	0.2100	94.3	14	0.0040	0.1314	96.9
15	0.0102	0.1500	93.2	16	0.0032	0.1150	97.3
17	0.0129	0.1324	90.3	18	0.0034	0.1022	97.7
19	0.0130	0.1184	88.3	20	0.0035	0.0920	97.2
21	0.0148	0.1071	86.3	22	0.0019	0.0838	97.8
23	0.0137	0.0878	88.0	24	0.0018	0.0767	97.9
25	0.0133	0.0800	85.2	26	0.0015	0.0708	97.3
27	0.0130	0.0633	84.4	28	0.0017	0.0657	97.3
29	0.0119	0.0776	84.7	30	0.0013	0.0613	97.8
31	0.0107	0.0726	85.3	32	0.0012	0.0575	98.0
33	0.0094	0.0652	86.1	34	0.0012	0.0541	97.7
35	0.0091	0.0643	85.9	36	0.0011	0.0511	97.8
37	0.0079	0.0608	87.1	38	0.0013	0.0484	97.2
39	0.0077	0.0577	86.6	40	0.0012	0.0480	97.4

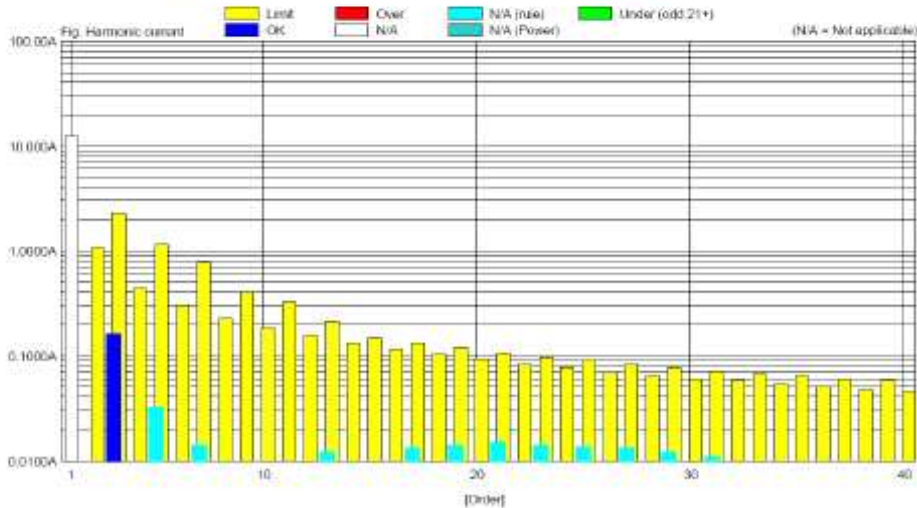

Bureau Veritas Shenzhen Co., Ltd.
 Dongguan Branch

No. 34, Chenwulu Section, Guantai Rd., Houjie
 Town, Dongguan City,
 Guangdong 523942, China

Tel: +86 769 8593 5656
 Fax: +86 769 8593 1080
 Email: customerservice.dg@cn.bureauveritas.com

***** appliances (Maximum)

Print Date : Wed Jun 11 11:32:39 2014
 MeasureDate : Wed Jun 11 11:31:38 2014
 Comment : Experimental model Pattern A

Regulation : IEC61000-3-2 Ed3.0 am2
 IEC61000-4-7 Ed2.0 A1
 Class : CLASS A
 MeasureTime : 150.00sec
 Model : YOKOGAWA WT3000
 Rating Voltage : 230.00 V
 Wiring : single-phase 2-wire
 Element : 2
 Range : 300V/30A
 Current(rms) : 12.1941 A
 Voltage(rms) : 229.89 V
 Frequency : 50.018 Hz
 Power Factor : 0.9998
 Beyond Limit Time : 15.0002 s
 Beyond Total Time : 0.0000 s
 THC : 0.1694 A

PASS

Set Fundamental I : -----
 Set Power Factor : -----
 Set P : -----
 Sigma W Max : 2904.014 W
 Sigma PF : 0.9998
 Distortion factor(V) : 0.04 %
 V THDS : 0.04 %
 V THDG : 0.04 %
 Distortion factor(A) : 1.40 %
 A THDS : 1.40 %
 A THDG : 1.40 %
 P THD : 0.00 %
 Power Limit : 75 W

Order	Measure[A]	Limit[A]	Margin[%]	Order	Measure[A]	Limit[A]	Margin[%]
1	12.1929			2	0.0067	1.6200	99.5
3	0.1691	3.4500	95.4	4	0.0067	0.6450	99.0
5	0.0322	1.7100	98.1	5	0.0032	0.4500	99.2
7	0.0146	1.1550	98.7	8	0.0054	0.3450	99.0
9	0.0068	0.8000	99.0	10	0.0041	0.2760	99.3
11	0.0050	0.4950	99.7	12	0.0040	0.2300	99.2
13	0.0129	0.3150	95.9	14	0.0061	0.1971	97.4
15	0.0190	0.2250	95.2	16	0.0035	0.1725	99.0
17	0.0194	0.1995	93.3	18	0.0027	0.1533	99.2
19	0.0142	0.1776	92.0	20	0.0028	0.1380	97.9
21	0.0190	0.1807	90.7	22	0.0021	0.1256	99.4
23	0.0139	0.1467	90.5	24	0.0019	0.1150	99.4
25	0.0130	0.1350	89.9	26	0.0022	0.1062	99.0
27	0.0132	0.1250	89.4	28	0.0020	0.0980	99.0
29	0.0121	0.1164	89.6	30	0.0019	0.0920	99.4
31	0.0108	0.1089	90.0	32	0.0019	0.0862	99.5
33	0.0097	0.1023	90.6	34	0.0014	0.0812	99.3
35	0.0092	0.0964	90.4	36	0.0012	0.0767	99.4
37	0.0081	0.0912	91.1	38	0.0016	0.0726	97.9
39	0.0076	0.0865	90.8	40	0.0014	0.0680	97.9

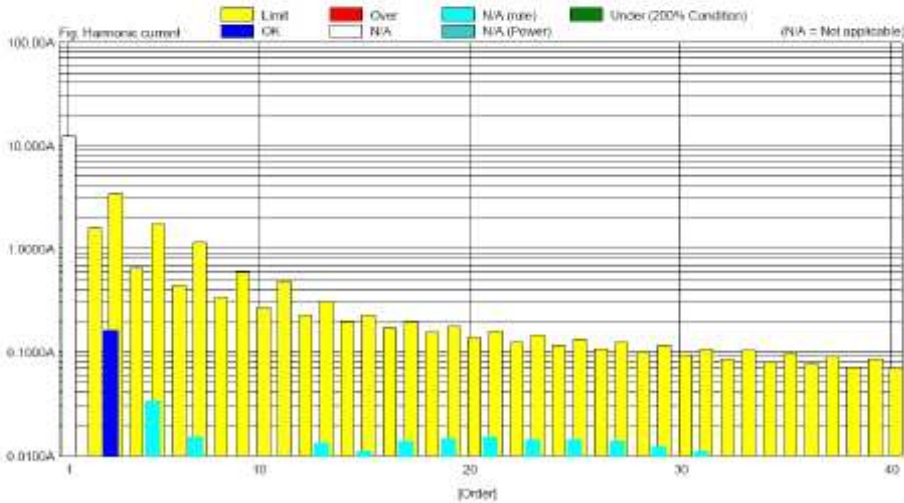

Bureau Veritas Shenzhen Co., Ltd.
 Dongguan Branch

No. 34, Chenwulu Section, Guantai Rd., Houjie
 Town, Dongguan City,
 Guangdong 523942, China

Tel: +86 769 8593 5656
 Fax: +86 769 8593 1080
 Email: customerservice.dg@cn.bureauveritas.com



BUREAU VERITAS Test Report No.: CE140508N005R1

3.4 VOLTAGE FLUCTUATION AND FLICKS MEASUREMENT

3.4.1 LIMITS OF VOLTAGE FLUCTUATION AND FLICKS MEASUREMENT

TEST STANDARD: EN 61000-3-3

TEST ITEM	LIMIT	NOTE
P_{st}	1.0	P_{st} means short-term flicker indicator.
P_{lt}	0.65	P_{lt} means long-term flicker indicator.
$T_{d(t)}$ (ms)	500	$T_{d(t)}$ means maximum time that $d(t)$ exceeds 3.3%.
d_{max} (%)	4	d_{max} means maximum relative voltage change.
dc (%)	3.3	dc means relative steady-state voltage change

3.4.2 TEST INSTRUMENTS

DESCRIPTION & MANUFACTURER	MANUFACTURER	MODEL NO.	SERIAL NO.	CALIBRATED DATE	CALIBRATED UNTIL
PRECISION POWER ANALYZER	YOKOGAWA	WT3000	91M210852	Mar. 12,14	Mar. 11,15
Test Software	YOKOGAWA	IEC61000	N/A	N/A	N/A
REFERENCE IMPEDANCE NETWORK	Voltech	EUR	3018	N/A	N/A

NOTE: 1. The test was performed in PV Room.

2. The calibration interval of the above test instruments is 12 months and the calibrations are traceable to CEPREI/CHINA, GRGT/CHINA and NIM/CHINA.

3.4.3 TEST PROCEDURE

- a. The EUT was placed on the top of a wooden table 0.8 meters above the ground and operated to produce the most unfavorable sequence of voltage changes under Normal Operating conditions.
- b. During the flick measurement, the measure time shall include that part of whole operation cycle in which the EUT produce the most unfavorable sequence of voltage changes. The observation period for short-term flicker indicator is 120 minutes

Bureau Veritas Shenzhen Co., Ltd.
Dongguan Branch

No. 34, Chenwulu Section, Guantai Rd., Houjie
Town, Dongguan City,
Guangdong 523942, China

Tel: +86 769 8593 5656
Fax: +86 769 8593 1080
Email: customerservice.dg@cn.bureauveritas.com

Page 32 of 66

Report Version 1

Bureau Veritas Shenzhen Co., Ltd.
Dongguan Branch

No. 34, Chenwulu Section, Guantai Rd.,
Houjie Town, Dongguan City, Guangdong
523942, China

Page 66 of 127

Tel: +86 769 8593 5656
Fax: +86 769 8599 1080
Email: customerservice.dg@cn.bureauveritas.com

TEST REPORT EN 50438 VER.1



3.4.4 DEVIATION FROM TEST STANDARD

No deviation

3.4.5 TEST SETUP

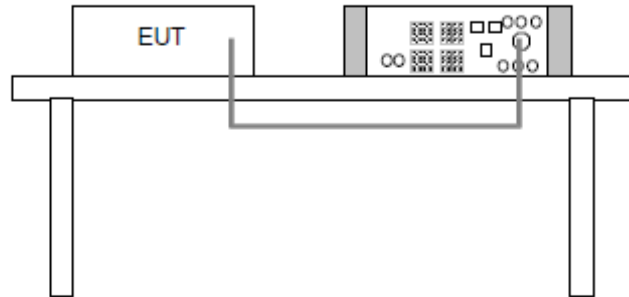

3.4.6 EUT OPERATING CONDITIONS

Same as item 3.1.6.



3.4.7 TEST RESULTS

SOFAR 1100TL

PV Inverter

Print Date : Mon May 26 16:26:18 2014
 MeasureDate : Mon May 26 16:25:54 2014
 Comment : Experimental model Pattern A

Regulation : IEC81000-3-3 Ed2.0
 IEC81000-4-15 Ed1.1
 Interval : 10Min0Sec
 Model : YOKOGAWA WT3000
 Wiring : single-phase 2-wire
 Voltage Range : 300.00V
 Voltage U1 : 231.81V
 Set Frequency : 50Hz
 Frequency U1 : 50.000Hz
 Element : 1
 dmin : 0.10%

PASS(Under dmin)

Element1 : Pass(Under dmin)
 dc (3.30%) : Pass
 dmax (4.00%) : Pass
 d(t) (500ms) : Pass
 Pst (1.00) : Pass
 PIt (0.65) : Pass

No.	dc[%]	dmax[%]	d(t)[ms]	Pst
1	0.00	0.00	0.00	0.07
2	0.00	0.00	0.00	0.07
3	0.00	0.00	0.00	0.07
4	0.00	0.00	0.00	0.07
5	0.00	0.00	0.00	0.07
6	0.00	0.00	0.00	0.07
7	0.00	0.00	0.00	0.07
8	0.00	0.00	0.00	0.07
9	0.00	0.00	0.00	0.07
10	0.00	0.00	0.00	0.07
11	0.00	0.00	0.00	0.07
12	0.00	0.00	0.00	0.07
			PIt	0.07



PV Inverter

Print Date : Fri Jun 13 11:17:38 2014
 Measure Date : Fri Jun 13 11:17:28 2014
 Comment : Experimental model Pattern A

Regulation : IEC61000-3-3 Ed2.0
 IEC61000-4-15 Ed1.1
 Interval : 10Min0Sec
 Model : YOKOGAWA WT3000
 Wiring : single-phase 2-wire
 Voltage Range : 300.00V
 Voltage U1 : 234.15V
 Set Frequency : 50Hz
 Frequency U1 : 50.000Hz
 Element : 1
 dmin : 0.10%

PASS(Under dmin)

Element1 : Pass(Under dmin)
 dc (3.30%) : Pass
 dmax (4.00%) : Pass
 d(t) (500ms) : Pass
 Pst (1.00) : Pass
 PIt (0.66) : Pass

No.	dc[%]	dmax[%]	d(t)[ms]	Pst
1	0.00	0.00	0.00	0.07
2	0.00	0.00	0.00	0.07
3	0.00	0.00	0.00	0.07
4	0.00	0.00	0.00	0.07
5	0.00	0.00	0.00	0.07
6	0.00	0.00	0.00	0.07
7	0.00	0.00	0.00	0.07
8	0.00	0.00	0.00	0.07
9	0.00	0.00	0.00	0.07
10	0.00	0.00	0.00	0.07
11	0.00	0.00	0.00	0.07
12	0.00	0.00	0.00	0.07

Pst
0.07



BUREAU VERITAS Test Report No.: CE140508N005R1

4 IMMUNITY TEST

4.1 GENERAL DESCRIPTION

4.1.1 GENERAL DESCRIPTION OF EN 61000-6-2

Product Standard:	EN 61000-6-2:2005	
Basic Standard, specification requirement, and Performance Criteria:	IEC 61000-4-2	Electrostatic Discharge – ESD: 4kV Contact discharge, 8kV air discharge, Performance Criterion B
	IEC 61000-4-3	Radio-Frequency Electromagnetic Field Susceptibility Test – RS: 80-1000 MHz, 10V/m, 80% AM (1kHz), 1400-2000 MHz, 3V/m, 80% AM (1kHz) 2000-2700 MHz, 1V/m, 80% AM (1kHz) Performance Criterion A
	IEC 61000-4-4	Electrical Fast Transient/Burst - EFT AC Power line: 2kV, DC Power line: 2kV Signal line: 1kV Performance Criterion B
	IEC 61000-4-5	Surge Immunity Test: 1.2/50 us Open Circuit Voltage, 8 /20 us Short Circuit Current, AC Power Line: line to line 1 kV, line to earth 2kV DC Power Line: line to line 0.5kV line to earth 0.5kV Signal line: 1kV Performance Criterion B
	IEC 61000-4-6	Conducted Radio Frequency Disturbances Test – CS: 0.15-80 MHz, 10Vrms, 80% AM, 1kHz, Performance Criterion A
	IEC 61000-4-8	Power Frequency Magnetic Field Test, 50 Hz, 30A/m, Performance Criterion A

Bureau Veritas Shenzhen Co., Ltd.
Dongguan Branch

No. 34, Chenwulu Section, Guantai Rd., Houjie Town, Dongguan City, Guangdong 523942, China

Tel: +86 769 8593 5656
Fax: +86 769 8593 1080
Email: customerservice.dg@cn.bureauveritas.com

Page 36 of 66

Report Version 1

Bureau Veritas Shenzhen Co., Ltd.
Dongguan Branch

No. 34, Chenwulu Section, Guantai Rd., Houjie Town, Dongguan City, Guangdong 523942, China

Page 70 of 127

Tel: +86 769 8593 5656
Fax: +86 769 8599 1080
Email: customerservice.dg@cn.bureauveritas.com

TEST REPORT EN 50438 VER.1



4.1.2 PERFORMANCE CRITERIA

According to Clause 4 of EN 61000-6-2:2005 standard, the following describes the general performance criteria.

CRITERION A	The apparatus shall continue to operate as intended during and after the test. No degradation of performance or loss of function is allowed below a performance level specified by the manufacturer, when the apparatus is used as intended. The performance level may be replaced by a permissible loss of performance. If the minimum performance level or the permissible performance loss is not specified by the manufacturer, either of these may be derived from the product description and documentation and what the user may reasonably expect from the apparatus if used as intended.
CRITERION B	The apparatus shall continue to operate as intended after the test. No degradation of performance or loss of function is allowed below a performance level specified by the manufacturer, when the apparatus is used as intended. The performance level may be replaced by a permissible loss of performance. During the test, degradation of performance is however allowed. No change of operating state or stored data is allowed. If the minimum performance level or the permissible performance loss is not specified by the manufacturer, either of these may be derived from the product description and documentation and what the user may reasonably expect from the apparatus if used as intended.
CRITERION C	Temporary loss of function is allowed, provided the function is self-recoverable or can be restored by the operation of the controls.

4.1.3 EUT OPERATING CONDITION

Same as item 3.1.6



4.2 ELECTROSTATIC DISCHARGE IMMUNITY TEST (ESD)

4.2.1 TEST SPECIFICATION

Basic Standard:	IEC 61000-4-2
Discharge Impedance:	330 ohm / 150 pF
Discharge Voltage:	Air Discharge: 8 kV (Direct) Contact Discharge: 4 kV (Indirect)
Polarity:	Positive & Negative
Number of Discharge:	20 times at each test point
Discharge Mode:	Single Discharge
Discharge Period:	1 second

4.2.2 TEST INSTRUMENTS

Equipment	Manufacturer	Model No.	Serial No.	Last Cal.	Next Cal.
ESD Generator	TESEQ	NSG 437	279	Oct. 12, 13	Oct. 11, 14
Test Software	TESEQ	V03.03	N/A	N/A	N/A
ESD Generator	EM TEST	Dito	V1211112265	Jun. 19,14	Jun. 18,15
Test Software	EM TEST	V 2.31	N/A	N/A	N/A

NOTE: 1. The test was performed in ESD Room.

2. The calibration interval of the above test instruments is 12 months and the calibrations are traceable to CEPREI/CHINA, GRGT/CHINA and NIM/CHINA.



4.2.3 TEST PROCEDURE

The basic test procedure was in accordance with IEC 61000-4-2:

- a. Electrostatic discharges were applied only to those points and surfaces of the EUT that are accessible to users during normal operation.
- b. The test was performed with at least ten single discharges on the pre-selected points in the most sensitive polarity.
- c. The time interval between two successive single discharges was at least 1 second.
- d. The ESD generator was held perpendicularly to the surface to which the discharge was applied and the return cable was at least 0.2 meters from the EUT.
- e. Contact discharges were applied to the non-insulating coating, with the pointed tip of the generator penetrating the coating and contacting the conducting substrate.
- f. Air discharges were applied with the round discharge tip of the discharge electrode approaching the EUT as fast as possible (without causing mechanical damage) to touch the EUT. After each discharge, the ESD generator was removed from the EUT and re-triggered for a new single discharge. The test was repeated until all discharges were complete.
- g. At least ten single discharges (in the most sensitive polarity) were applied to the Horizontal Coupling Plane at points on each side of the EUT. The ESD generator was positioned horizontal at a distance of 0.1 meters from the EUT with the discharge electrode touching the HCP.
- h. At least ten single discharges (in the most sensitive polarity) were applied to the center of one vertical edge of the Vertical Coupling Plane in sufficiently different positions that the four faces of the EUT were completely illuminated. The VCP (dimensions 0.5m x 0.5m) was placed vertically to and 0.1 meters from the EUT.

4.2.4 DEVIATION FROM TEST STANDARD

No Deviation

4.2.5 TEST SETUP

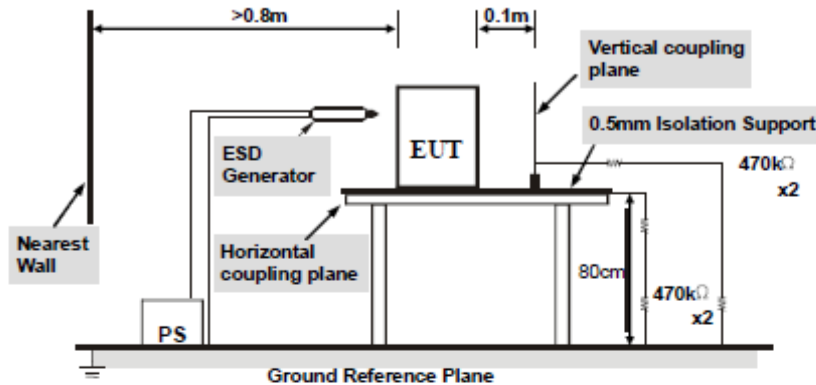

NOTE:

TABLE-TOP EQUIPMENT

The configuration consisted of a wooden table 0.8 meters high standing on the Ground Reference Plane. The GRP consisted of a sheet of aluminum at least 0.25mm thick, and 2.5 meters square connected to the protective grounding system. A Horizontal Coupling Plane (1.6m x 0.8m) was placed on the table and attached to the GRP by means of a cable with 940kΩ total impedance. The equipment under test, was installed in a representative system as described in section 7 of IEC 61000-4-2, and its cables were placed on the HCP and isolated by an insulating support of 0.5mm thickness. A distance of 1-meter minimum was provided between the EUT and the walls of the laboratory and any other metallic structure.

FLOOR-STANDING EQUIPMENT

The equipment under test was installed in a representative system as described in section 7 of IEC 61000-4-2, and its cables were isolated from the Ground Reference Plane by an insulating support of 0.1-meter thickness. The GRP consisted of a sheet of aluminum that is at least 0.25mm thick, and 2.5 meters square connected to the protective grounding system and extended at least 0.5 meters from the EUT on all sides.



4.2.6 TEST RESULTS

TEST MODE	See item 2.2	TEST VOLTAGE	DC 300V
ENVIRONMENTAL CONDITIONS	21.2deg. C, 51% RH 101.3kPa	TESTED BY: Heise	

Direct Discharge Application				
Test Level (kV)	Polarity	Test Point	Test Result of Contact Discharge	Test Result of Air Discharge
4	+/-	All Metal Part	A	N/A
8	+/-	All Non-metal Part	N/A	A

Indirect Discharge Application				
Discharge Level (kV)	Polarity	Test Point	Test Result of HCP	Test Result of VCP
4	+/-	HCP&VCP	A	A

NOTE: A: There was no change compared with initial operation during the test.



4.3 RADIATED, RADIO-FREQUENCY, ELECTROMAGNETIC FIELD IMMUNITY TEST (RS)

4.3.1 TEST SPECIFICATION

Basic Standard:	IEC 61000-4-3
Frequency Range:	80-1000MHz, 1400-2000MHz, 2000-2700MHz
Field Strength:	10V/m, 3V/m, 1V/m
Modulation:	1kHz Sine Wave, 80%, AM Modulation
Frequency Step:	1 % of fundamental
Polarity of Antenna:	Horizontal and Vertical
Antenna Height:	1.5m
Dwell Time:	at least 3 seconds

4.3.2 TEST INSTRUMENTS

Equipment	Manufacturer	Model No.	Serial No.	Last Cal.	Next Cal.
Signal Generator	Agilent	N5181A	MY50142530	Nov. 01,13	Oct. 31,14
Antenna Log-Periodic	CORAD	ATR80M6G	0337307	N/A	N/A
Antenna Log-Periodic	CORAD	ATS700M11G	0336821	N/A	N/A
Switch Controller	CORAD	SC1000	0337343	N/A	N/A
RF Power Meter	ESE	4242	13984	Nov. 04,13	Nov. 03,14
Power Sensor	ESE	51011EMC	35716	Nov. 04,13	Nov. 03,14
Power Sensor	ESE	51011EMC	35715	Nov. 04,13	Nov. 03,14
E-Field probe	Narda	NBM-520	2403/01B	May 07,14	May 06,15
Power Amplifier	TESEQ	CBA 1G-150	T44029	N/A	N/A
Power Amplifier	TESEQ	CBA 3G-100	T44030	N/A	N/A
Power Amplifier	TESEQ	CBA 6G-050	1041204	N/A	N/A
Dual Directional Coupler	TESEQ	C5982	95208	Dec. 23,13	Dec. 22,14
Dual Directional Coupler	TESEQ	C6187	95175	Dec. 23,13	Dec. 22,14
Dual Directional Coupler	TESEQ	CPH-274F	M251304-01	Dec. 23,13	Dec. 22,14
Test Software	ADT	BVADT_RS_V7.6 .4-DG	N/A	N/A	N/A

NOTE: 1. The test was performed in RS chamber.

2. The calibration interval of the above test instruments is 12 months and the calibrations are traceable to CEPREI/CHINA, GRGT/CHINA and NIM/CHINA.

Bureau Veritas Shenzhen Co., Ltd.
Dongguan Branch

No. 34, Chenwulu Section, Guantai Rd., Houjie
Town, Dongguan City,
Guangdong 523942, China

Tel: +86 769 8593 5656
Fax: +86 769 8593 1080
Email: customerservice.dg@cn.bureauveritas.com



4.3.3 TEST PROCEDURE

The test procedure was in accordance with IEC 61000-4-3

- a. The testing was performed in a fully-anechoic chamber.
- b. The frequency range is swept from 80 MHz to 1000 MHz, 1400MHz to 2000MHz, 2000MHz to 2700MHz with the signal 80% amplitude modulated with a 1kHz sine wave.
- c. The dwell time at each frequency shall not be less than the time necessary for the EUT to be exercised and to respond, but shall in no case be less than 0,5s.
- d. The field strength levels were 10V/m, 3V/m, 1V/m.
- e. The test was performed with the EUT exposed to both vertically and horizontally polarized fields on each of the four sides.

4.3.4 DEVIATION FROM TEST STANDARD

No Deviation

4.3.5 TEST SETUP

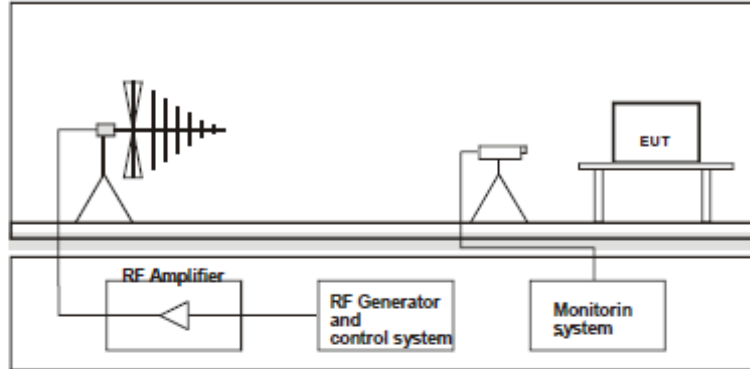

NOTE:

TABLETOP EQUIPMENT

The EUT installed in a representative system as described in section 7 of IEC 61000-4-3 was placed on a non-conductive table 0.8 meters in height. The system under test was connected to the power and signal wire according to relevant installation instructions.

FLOOR STANDING EQUIPMENT

The EUT installed in a representative system as described in section 7 of IEC 61000-4-3 was placed on a non-conductive wood support 0.1 meters in height. The system under test was connected to the power and signal wire according to relevant installation instructions.



4.3.6 TEST RESULTS

TEST MODE	See item 2.2	TEST VOLTAGE	DC 300V
ENVIRONMENTAL CONDITIONS	21.6deg. C, 57.5% RH	TESTED BY:	Heise

Field Strength (V/m)	Test Frequency Note#1 (MHz)	Polarization of antenna (Horizontal / Vertical)	Test Distance (m)	Test Result	Remark
10	80 - 1000	H&V	3	A	N/A
3	1400 - 2000	H&V	3	A	N/A
1	2000 - 2700	H&V	3	A	N/A

Note*1:

Tested Israel SII Frequencies 89,100,107,144,163,196,244,315,434,460,600,825,845,880 MHz

NOTE: A: There was no change compared with initial operation during the test.



4.4 ELECTRICAL FAST TRANSIENT/BURST IMMUNITY TEST (EFT)

4.4.1 TEST SPECIFICATION

Basic Standard:	IEC 61000-4-4
Test Voltage:	Power Line: 2kV
Polarity:	Positive & Negative
Impulse Frequency:	5 kHz
Impulse Waveshape :	5/50 ns
Burst Duration:	15 ms
Burst Period:	300 ms
Test Duration:	1 min.

4.4.2 TEST INSTRUMENTS

Equipment	Manufacturer	Model No.	Serial No.	Last Cal.	Next Cal.
EFT Tester	HAEFELY	PEFT4010	150546	May 17,14	May 16,15
EFT Coupling Clamp	HAEFELY	IP4A	150407	May 17,14	May 16,15
Test Software	HAEFELY	SWPE4010 1.22	N/A	N/A	N/A

NOTE: 1. The test was performed in EMS Room 1.

2. The calibration interval of the above test instruments is 12 months and the calibrations are traceable to CEPREI/CHINA, GRGT/CHINA and NIM/CHINA.

4.4.3 TEST PROCEDURE

- Both positive and negative polarity discharges were applied.
- The length of the "hot wire" from the coaxial output of the EFT generator to the terminals on the EUT should not exceed 0.5 meter \pm 0.05 meter.
- The duration time of each test sequential was 1 minute.
- The transient/burst waveform was in accordance with IEC 61000-4-4, 5/50ns.

4.4.4 DEVIATION FROM TEST STANDARD

No deviation.

4.4.5 TEST SETUP

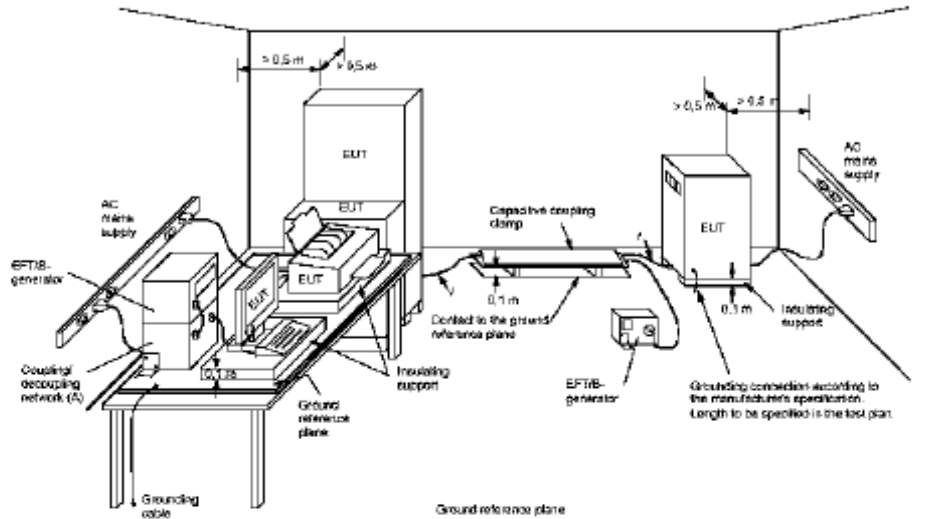

NOTE:

TABLETOP EQUIPMENT

The configuration consisted of a wooden table standing on the Ground Reference Plane and should be located 0.1m +/- 0.01m above the Ground Reference Plane.

The GRP consisted of a sheet of aluminum (at least 0.25mm thick and 2.5m square) connected to the protective grounding system. A minimum distance of 0.5m was provided between the EUT and the walls of the laboratory or any other metallic structure.

FLOOR STANDING EQUIPMENT

The EUT installed in a representative system as described in section 7 of IEC 61000-4-4 and its cables, were isolated from the Ground Reference Plane by an insulating support that is 0.1-meter thick. The GRP consisted of a sheet of aluminum (at least 0.25mm thick and 2.5m square) connected to the protective grounding system.

Bureau Veritas Shenzhen Co., Ltd.
Dongguan Branch

No. 34, Chenwulu Section, Guantai Rd., Houjie
Town, Dongguan City,
Guangdong 523942, China

Tel: +86 769 8593 5656
Fax: +86 769 8593 1080
Email: customerservice.dg@cn.bureauveritas.com

Page 47 of 66

Report Version 1

Bureau Veritas Shenzhen Co., Ltd.
Dongguan Branch

No. 34, Chenwulu Section, Guantai Rd.,
Houjie Town, Dongguan City, Guangdong
523942, China

Page 81 of 127

Tel: +86 769 8593 5656
Fax: +86 769 8599 1080
Email: customerservice.dg@cn.bureauveritas.com
TEST REPORT EN 50438 VER.1



4.4.6 TEST RESULTS

TEST MODE	See item 2.2	TEST VOLTAGE	DC 300V
ENVIRONMENTAL CONDITIONS	21.5 deg. C, 58.2% RH	TESTED BY: Heise	

Pulse Voltage	2 kV		kV		kV		kV	
	+	-	+	-	+	-	+	-
L	A	A	/	/	/	/	/	/
N	A	A	/	/	/	/	/	/
PE	A	A	/	/	/	/	/	/
L+N	A	A	/	/	/	/	/	/
L+PE	A	A	/	/	/	/	/	/
N+PE	A	A	/	/	/	/	/	/
L+N+PE	A	A	/	/	/	/	/	/
DC Line	A	A	/	/	/	/	/	/

NOTE: A: There was no change compared with initial operation during the test.



BUREAU VERITAS Test Report No.: CE140508N005R1

4.5 SURGE IMMUNITY TEST

4.5.1 TEST SPECIFICATION

Basic Standard:	IEC 61000-4-5
Wave-Shape:	Combination Wave 1.2/50 us Open Circuit Voltage 8 /20 us Short Circuit Current
Test Voltage:	AC Power Line: Line to Line:1kV Line to PE:2kV Signal Line: 1kV DC Power Line: Line to Line:0.5kV Line to PE:0.5kV
Surge Input/Output:	L-N&L-PE&N-PE, RJ 45 Line
Generator Source	2 ohm between networks
Impedance:	12 ohm between network and ground
Polarity:	Positive/Negative
Phase Angle:	0° /90°/180°/270°
Pulse Repetition Rate:	1 time / 60 sec.
Number of Tests:	5 positive and 5 negative at selected points

4.5.2 TEST INSTRUMENTS

Equipment	Manufacturer	Model No.	Serial No.	Last Cal.	Next Cal.
Combination wave Module	TESEQ AG	CDN 3061	1361	Feb. 17, 14	Feb. 16, 15
Telecom Surge Module	TESEQ AG	NSG 3060 Mainframe	1404	Feb. 17, 14	Feb. 16, 15
CDN	TESEQ	CDN HSS-2	34275	Nov.06, 13	Nov.05, 14
CDN	TESEQ	CDN 118	30741	Nov.06, 13	Nov.05, 14
Test Software	TESEQ	CDM 3061_0002.30	1361	N/A	N/A
Test Software	TESEQ	HVM 3060_0002.30	293	N/A	N/A

- NOTE: 1. The test was performed in EMS Room 1.
2. The calibration interval of the above test instruments is 12 months and the calibrations are traceable to CEPREI/CHINA, GRGT/CHINA and NIM/CHINA.

Bureau Veritas Shenzhen Co., Ltd.
Dongguan Branch

No. 34, Chenwulu Section, Guantai Rd., Houjie
Town, Dongguan City,
Guangdong 523942, China

Tel: +86 769 8593 5656
Fax: +86 769 8593 1080
Email: customerservice.dg@cn.bureauveritas.com

Page 49 of 66

Report Version 1

Bureau Veritas Shenzhen Co., Ltd.
Dongguan Branch

No. 34, Chenwulu Section, Guantai Rd.,
Houjie Town, Dongguan City, Guangdong
523942, China
Page 83 of 127

Tel: +86 769 8593 5656
Fax: +86 769 8599 1080
Email: customerservice.dg@cn.bureauveritas.com
TEST REPORT EN 50438 VER.1



4.5.3 TEST PROCEDURE

a. For EUT power supply:

The surge is to be applied to the EUT power supply terminals via the capacitive coupling network. Decoupling networks are required in order to avoid possible adverse effects on equipment not under test that may be powered by the same lines, and to provide sufficient decoupling impedance to the surge wave. The power cord between the EUT and the coupling/decoupling networks shall be 2 meters in length (or shorter).

b. For test applied to unshielded unsymmetrically operated interconnection lines of EUT:

The surge is applied to the lines via the capacitive coupling. The coupling / decoupling networks shall not influence the specified functional conditions of the EUT. The interconnection line between the EUT and the coupling/decoupling networks shall be 2 meters in length (or shorter).

c. For test applied to unshielded symmetrically operated interconnection / telecommunication lines of EUT:

The surge is applied to the lines via gas arrestors coupling. Test levels below the ignition point of the coupling arrestor cannot be specified. The interconnection line between the EUT and the coupling/decoupling networks shall be 2 meters in length (or shorter).

4.5.4 DEVIATION FROM TEST STANDARD

No deviation.

4.5.5 TEST SETUP

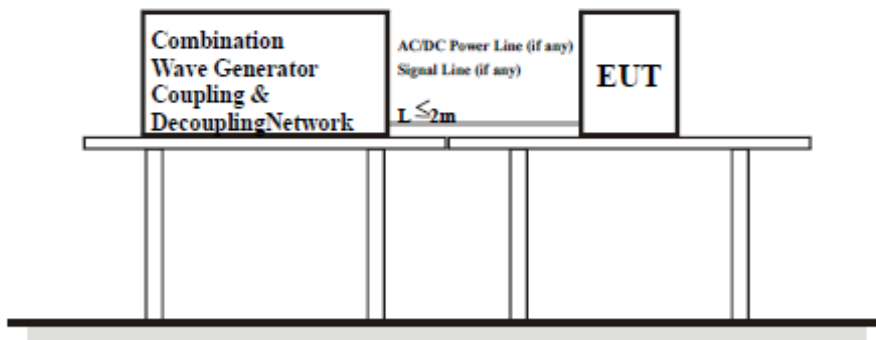



4.5.6 TEST RESULTS

TEST MODE	See item 2.2	TEST VOLTAGE	DC 300V
ENVIRONMENTAL CONDITIONS	21.5deg. C, 59.2% RH	TESTED BY: Heise	

AC/DC Power port:

Voltage (kV)	Phase angle \ Test point	Test result Polarity	0°	90°	180°	270°	DC Power Port
1	L-N	+	B	B	B	B	N/A
		-	B	B	B	B	N/A
2	L-PE	+	B	B	B	B	N/A
		-	B	B	B	B	N/A
2	N-PE	+	B	B	B	B	N/A
		-	B	B	B	B	N/A

Signal ports and telecommunication ports:

Voltage (kV)	Test Point	Polarity	Test result	Voltage (kV)	Test Point	Polarity	Test result
/	/	+/-	/	/	/	+/-	/

NOTE: A: There was no change compared with initial operation during the test.

B: During test, EUT stopped grid, and could automatically return to normal after test.



4.6 IMMUNITY TO CONDUCTED DISTURBANCES INDUCED BY RF FIELDS (CS)

4.6.1 TEST SPECIFICATION

Basic Standard:	IEC 61000-4-6
Frequency Range:	0.15 MHz - 80 MHz
Field Strength:	10V _{r.m.s}
Modulation:	1kHz Sine Wave, 80%, AM Modulation
Frequency Step:	1 % of fundamental
Coupled Cable:	Power Mains & DC Power Line
Coupling Device:	CDN-M3(3 wires) & Clamp

4.6.2 TEST INSTRUMENTS

Equipment	Manufacturer	Model No.	Serial No.	Last Cal.	Next Cal.
Signal Generator	Rohde&Schwarz	SME06	829498/006	Oct.15,13	Oct.14, 14
CDN	Luthi	L-801M2/M3	2015	Oct.18,13	Oct. 17,14
CDN(AUX)	TESEQ	CDN M016	27452	Nov. 20,13	Nov. 19,14
CDN	TESEQ	T200A	26944	Apr. 08,14	Apr. 07,15
CDN	TESEQ	T400A	26536	Apr. 08,14	Apr. 07,15
CDN	TESEQ	ST08A	32256	Apr. 08,14	Apr. 07,15
6dB 50Watt Attenuator	HUBER+SUHNER	5906.17.0005	303688	Oct.15,13	Oct.14,14
Signal Amplifier	HAEFELY	PAMP250	149594	NA	NA
Electromagnetic Injection Clamp	Luthi	EM101	35640	Oct.16,13	Oct.15,14
C/S Test System	HAEFELY	WinPAMP	NSEMC002	N/A	N/A
Test Software	ADT	BVADT_CS_V7.5.1	N/A	N/A	N/A

NOTE: 1. The test was performed in CS test room.

2. The calibration interval of the above test instruments is 12 months and the calibrations are traceable to CEPREI/CHINA, GRGT/CHINA and NIM/CHINA.



4.6.3 TEST PROCEDURE

- a. The EUT shall be tested within its intended operating and climatic conditions.
- b. An artificial hand was placed on the hand-held accessory and connected to the ground reference plane.
- c. The test shall be performed with the test generator connected to each of the coupling and decoupling devices in turn, while the other non-excited RF input ports of the coupling devices are terminated by a 50-ohm load resistor.
- d. The frequency range is swept from 150 kHz to 80 MHz, using the signal level established during the setting process and with a disturbance signal of 80 % amplitude. The signal is modulated with a 1 kHz sine wave, pausing to adjust the RF signal level or the switch coupling devices as necessary. Where the frequency is swept incrementally, the step size shall not exceed 1 % of the preceding frequency value.
- e. The dwell time of the amplitude modulated carrier at each frequency shall not be less than the time necessary for the EUT to be exercised and to respond, but shall in no case be less than 0,5 s. The sensitive frequencies (e.g. clock frequencies) shall be analyzed separately.
- f. Attempts should be made to fully exercise the EUT during testing, and to fully interrogate all exercise modes selected for susceptibility.

4.6.4 DEVIATION FROM TEST STANDARD

No deviation.

4.6.5 TEST SETUP

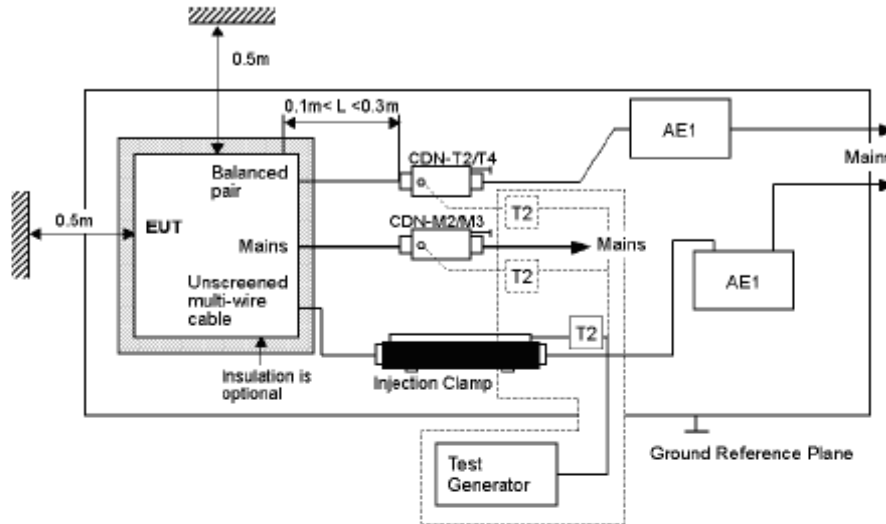

NOTE: The EUT clearance from any metallic obstacles shall be at least 0.5m.
All non-excited input ports of the CDNs shall be terminated by 50Ω loads.

NOTE:

FLOOR-STANDING EQUIPMENT

The equipment to be tested is placed on an insulating support of 0.1 meters height above a ground reference plane. All relevant cables shall be provided with the appropriate coupling and decoupling devices at a distance between 0.1 meters and 0.3 meters from the projected geometry of the EUT on the ground reference plane.



4.6.6 TEST RESULTS

TEST MODE	See Item 2.2	TEST VOLTAGE	DC 300V
ENVIRONMENTAL CONDITIONS	22.5deg. C, 56.6% RH	TESTED BY:	Heise

Voltage (V)	Test Frequency Note ^{#1} (MHz)	Tested Line	Injection Method.	Test Result	Remark
10	0.15 – 80	AC Mains	CDN-M3	A	N/A
10	0.15 – 80	DC line	Clamp	A	N/A

Note^{#1}: Tested Israel SII Frequencies 0.2,0.53,1,1.5,7.1,13.56,21,27.12,40.68,65,68 MHz

NOTE: A: There was no change compared with initial operation during the test.



4.7 POWER FREQUENCY MAGNETIC FIELD IMMUNITY TEST

4.7.1 TEST SPECIFICATION

Basic Standard:	IEC 61000-4-8
Frequency Range:	50Hz, 60Hz
Field Strength:	30A/m
Observation Time:	5 minute
Inductance Coil:	Rectangular type, 1mx1m

4.7.2 TEST INSTRUMENTS

Equipment	Manufacturer	Model No.	Serial No.	Last Cal.	Next Cal.
Magnetic Field Tester	HAEFELY	MAG100.1	150579	Oct.18,13	Oct.17,14
Test Software	N/A	N/A	N/A	N/A	N/A

NOTE: 1. The test was performed in Shielding Room 843.

2. The calibration interval of the above test instruments is 12 months and the calibrations are traceable to CEPREI/CHINA, GRGT/CHINA and NIM/CHINA.

4.7.3 TEST PROCEDURE

- The equipment is configured and connected to satisfy its functional requirements.
- The power supply, input and output circuits shall be connected to the sources of power supply, control and signal.
- The cables supplied or recommended by the equipment manufacturer shall be used. 1 meter of all cables used shall be exposed to the magnetic field.

4.7.4 DEVIATION FROM TEST STANDARD

No Deviation



4.7.5 TEST SETUP

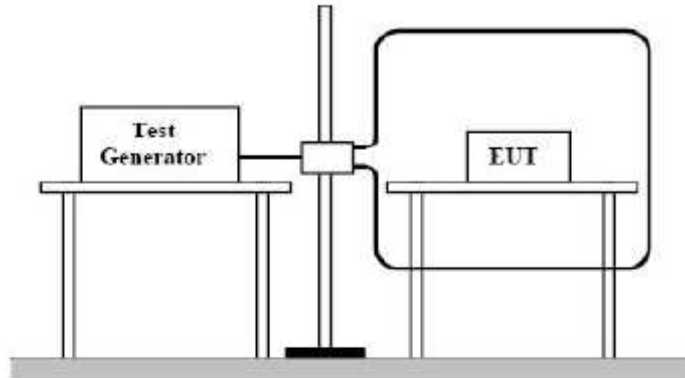

NOTE:

TABLETOP EQUIPMENT

The equipment shall be subjected to the test magnetic field by using the induction coil of standard dimension (1 m x 1 m). The induction coil shall then be rotated by 90 degrees in order to expose the EUT to the test field with different orientations.

FLOOR-STANDING EQUIPMENT

The equipment shall be subjected to the test magnetic field by using induction coils of suitable dimensions. The test shall be repeated by moving and shifting the induction coils, in order to test the whole volume of the EUT for each orthogonal direction. The test shall be repeated with the coil shifted to different positions along the side of the EUT, in steps corresponding to 50 % of the shortest side of the coil. The induction coil shall then be rotated by 90 degrees in order to expose the EUT to the test field with different orientations.



4.7.6 TEST RESULTS

TEST MODE	See Item 2.2	TEST VOLTAGE	DC 300V
ENVIRONMENTAL CONDITIONS	22deg. C, 59% RH	TESTED BY: Heise	

MAGNETIC FIELD DIRECTION	TESTING RESULT	REMARK
X - Axis	A	30A/ m
Y - Axis	A	30A/ m
Z - Axis	A	30A/ m

NOTE: A: There is no change compared with the initial operation during the test.



5 PHOTOGRAPHS OF THE TEST CONFIGURATION

CONDUCTED EMISSION TEST



RADIATED EMISSION TEST

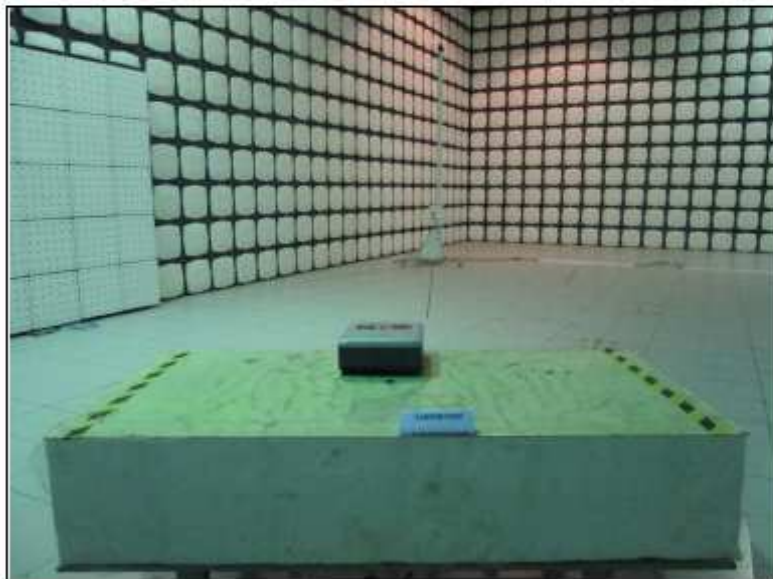
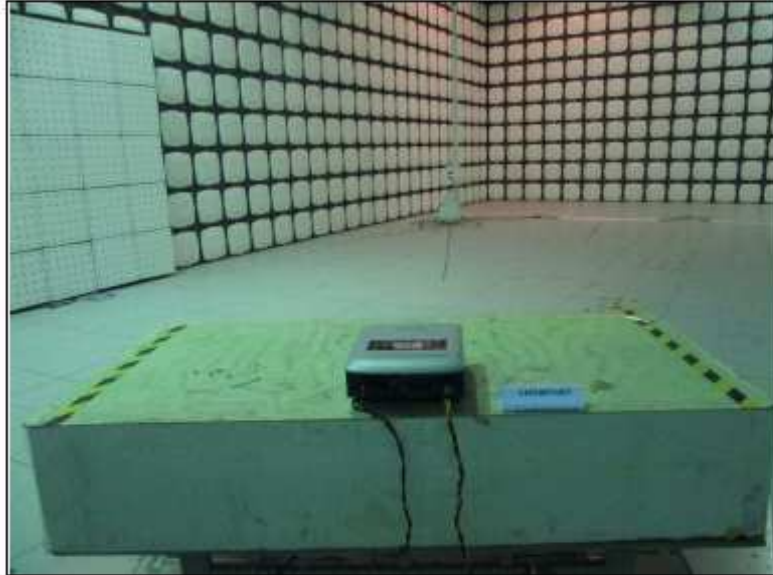

HARMONICS EMISSION TEST &
VOLTAGE FLUCTUATIONS AND FLICKER TEST



ESD TEST



Bureau Veritas Shenzhen Co., Ltd.
Dongguan Branch

No. 34, Chenwulu Section, Guantai Rd., Houjie
Town, Dongguan City,
Guangdong 523942, China

Tel: +86 769 8593 5656
Fax: +86 769 8593 1080
Email: customerservice.dg@cn.bureauveritas.com

Page 61 of 66

Report Version 1

Bureau Veritas Shenzhen Co., Ltd.
Dongguan Branch

No. 34, Chenwulu Section, Guantai Rd.,
Houjie Town, Dongguan City, Guangdong
523942, China
Page 95 of 127

Tel: +86 769 8593 5656
Fax: +86 769 8599 1080
Email: customerservice.dg@cn.bureauveritas.com
TEST REPORT EN 50438 VER.1

RS TEST

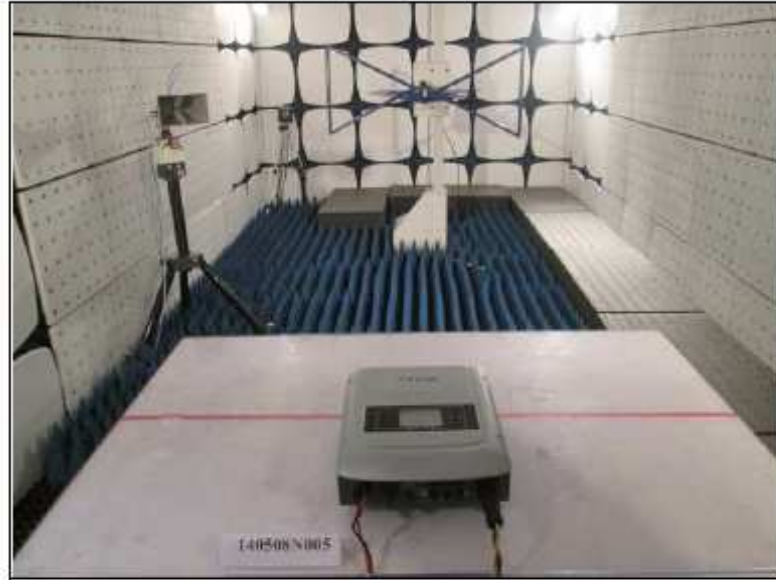

EFT TEST(AC Mains)



Test Report No.: CE140508N005R1

EFT TEST (DC Port)



SURGE TEST



CONDUCTED SUSCEPTIBILITY TEST (AC Mains)



CONDUCTED SUSCEPTIBILITY TEST (DC Cable)



POWER-FREQUENCY MAGNETIC FIELDS TEST



6 APPENDIX A – MODIFICATIONS RECORDERS FOR ENGINEERING CHANGES TO THE EUT BY THE LAB

No any modifications were made to the EUT by the lab during the test.

--END--

Bureau Veritas Shenzhen Co., Ltd.
Dongguan Branch

No. 34, Chenwulu Section, Guantai Rd., Houjie
Town, Dongguan City,
Guangdong 523942, China

Tel: +86 769 8593 5656
Fax: +86 769 8593 1080
Email: customerservice.dg@cn.bureauveritas.com

Page 66 of 66

Report Version 1

Bureau Veritas Shenzhen Co., Ltd.
Dongguan Branch

No. 34, Chenwulu Section, Guantai Rd.,
Houjie Town, Dongguan City, Guangdong
523942, China
Page 100 of 127

Tel: +86 769 8593 5656
Fax: +86 769 8599 1080
Email: customerservice.dg@cn.bureauveritas.com
TEST REPORT EN 50438 VER.1

PHOTOGRAPHS OF THE EUT SOFAR 1100TL:



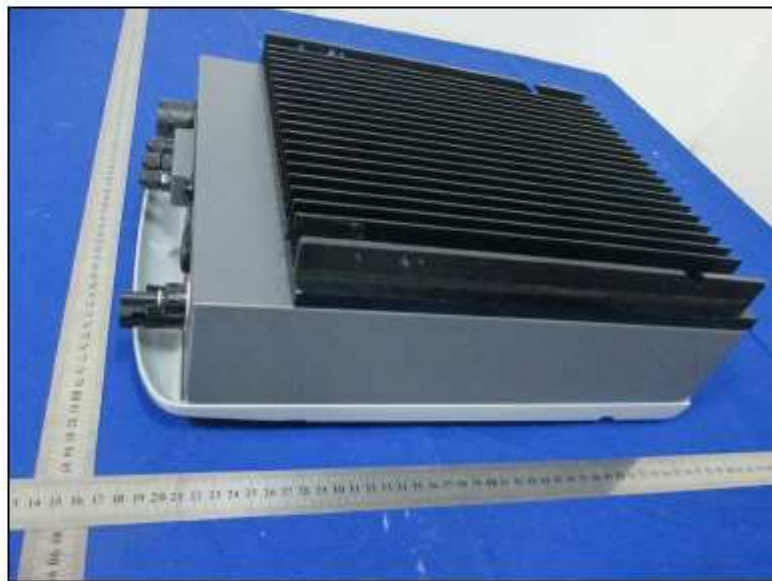
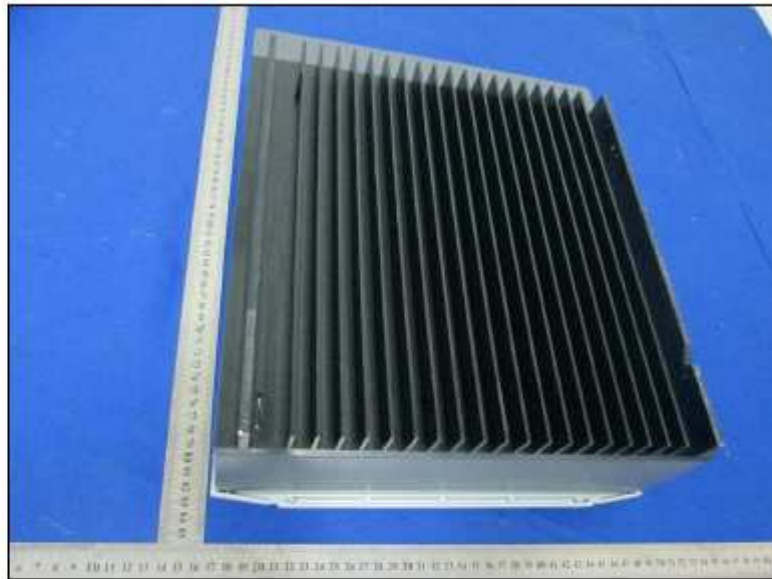

Bureau Veritas Shenzhen Co., Ltd.
Dongguan Branch

No. 34, Chenwulu Section, Guantai Rd., Houjie
Town, Dongguan City,
Guangdong 523942, China

Tel.: +86 769 8593 5656
Fax: +86 769 8593 1080
Email: customerservice.dg@cn.bureauveritas.com

Page 2 of 17

Report Version 1

Bureau Veritas Shenzhen Co., Ltd.
Dongguan Branch

No. 34, Chenwulu Section, Guantai Rd.,
Houjie Town, Dongguan City, Guangdong
523942, China
Page 102 of 127

Tel: +86 769 8593 5656
Fax: +86 769 8599 1080
Email: customerservice.dg@cn.bureauveritas.com
TEST REPORT EN 50438 VER.1



Bureau Veritas Shenzhen Co., Ltd.
Dongguan Branch

No. 34, Chenwulu Section, Guantai Rd., Houjie
Town, Dongguan City,
Guangdong 523942, China

Tel.: +86 769 8593 5656
Fax: +86 769 8593 1080
Email: customerservice.dg@cn.bureauveritas.com

Page 3 of 17

Report Version 1

Bureau Veritas Shenzhen Co., Ltd.
Dongguan Branch

No. 34, Chenwulu Section, Guantai Rd.,
Houjie Town, Dongguan City, Guangdong
523942, China
Page 103 of 127

Tel: +86 769 8593 5656
Fax: +86 769 8599 1080
Email: customerservice.dg@cn.bureauveritas.com
TEST REPORT EN 50438 VER.1

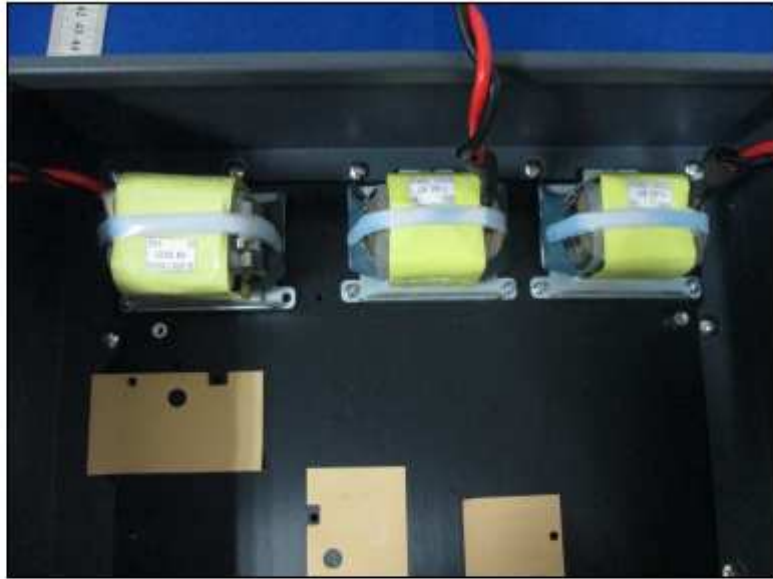



Bureau Veritas Shenzhen Co., Ltd.
Dongguan Branch

No. 34, Chenwulu Section, Guantai Rd., Houjie
Town, Dongguan City,
Guangdong 523942, China

Tel.: +86 769 8593 5656
Fax: +86 769 8593 1080
Email: customerservice.dg@cn.bureauveritas.com

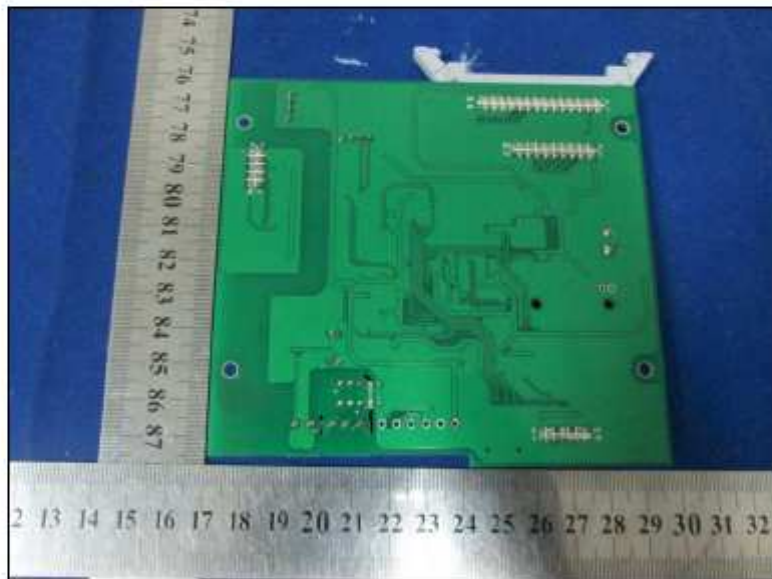

Bureau Veritas Shenzhen Co., Ltd.
Dongguan Branch

No. 34, Chenwulu Section, Guantai Rd., Houjie
Town, Dongguan City,
Guangdong 523942, China

Tel.: +86 769 8593 5656
Fax: +86 769 8593 1080
Email: customerservice.dg@cn.bureauveritas.com

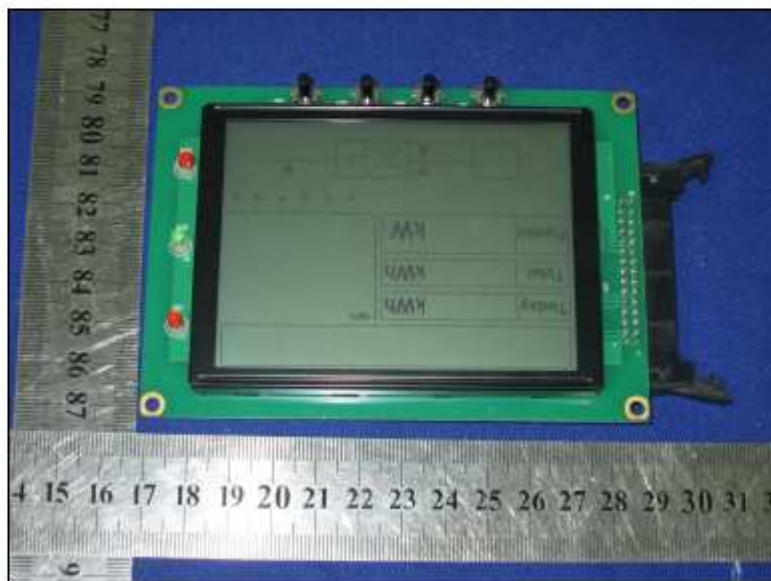



SOFAR 2200TL:



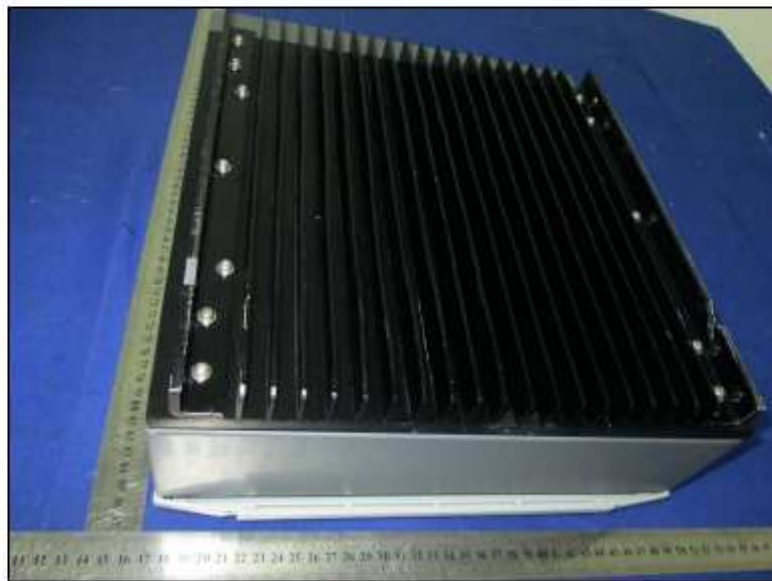

Bureau Veritas Shenzhen Co., Ltd.
Dongguan Branch

No. 34, Chenwulu Section, Guantai Rd., Houjie
Town, Dongguan City,
Guangdong 523942, China

Tel.: +86 769 8593 5656
Fax: +86 769 8593 1080
Email: customerservice.dg@cn.bureauveritas.com

Page 9 of 17

Report Version 1

Bureau Veritas Shenzhen Co., Ltd.
Dongguan Branch

No. 34, Chenwulu Section, Guantai Rd.,
Houjie Town, Dongguan City, Guangdong
523942, China
Page 109 of 127

Tel: +86 769 8593 5656
Fax: +86 769 8599 1080
Email: customerservice.dg@cn.bureauveritas.com
TEST REPORT EN 50438 VER.1



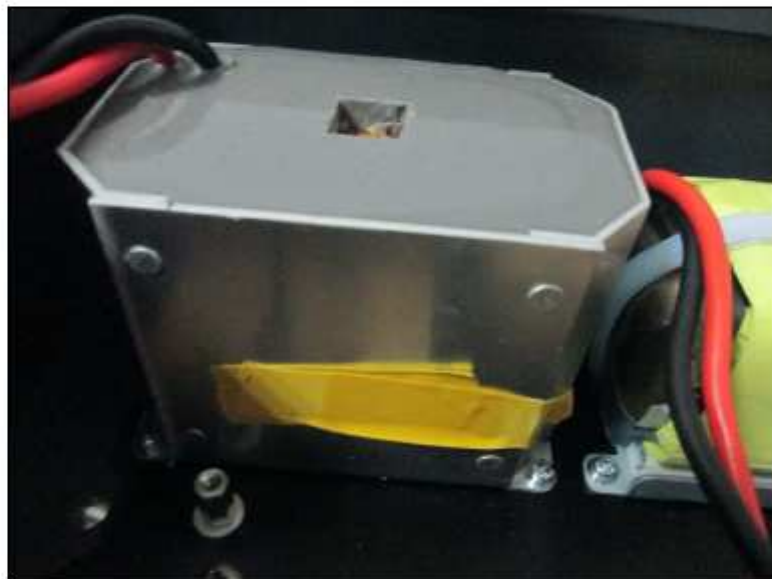

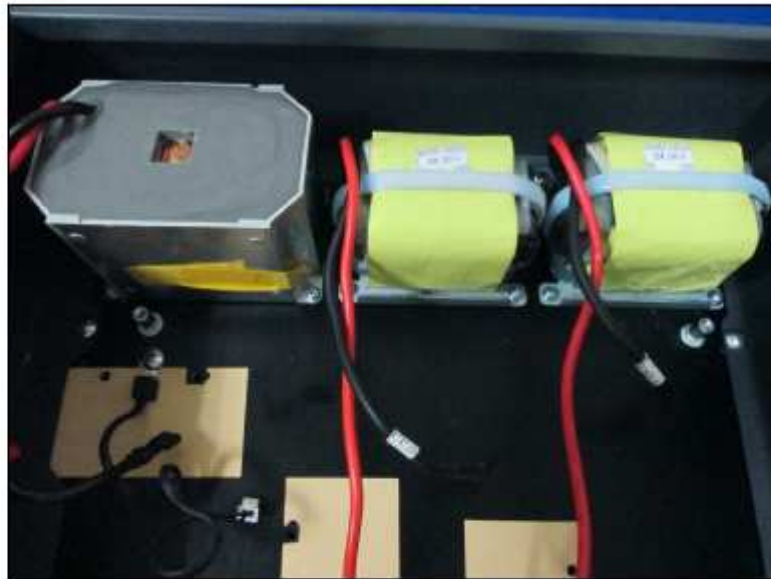

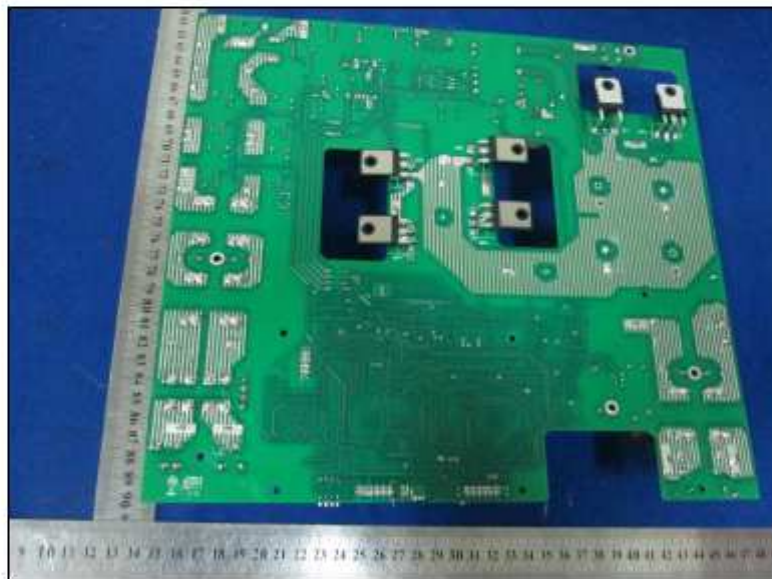

Bureau Veritas Shenzhen Co., Ltd.
Dongguan Branch

No. 34, Chenwulu Section, Guantai Rd., Houjie
Town, Dongguan City,
Guangdong 523942, China

Tel.: +86 769 8593 5656
Fax: +86 769 8593 1080
Email: customerservice.dg@cn.bureauveritas.com



BUREAU
VERITAS

Reference No.: 140508N005R1

SOFAR 3000TL:

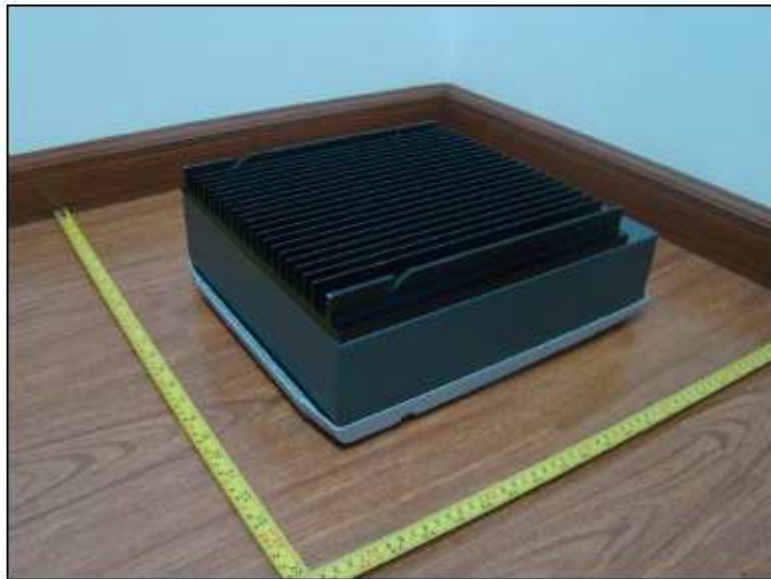

Bureau Veritas Shenzhen Co., Ltd.
Dongguan Branch

No. 34, Chenwulu Section, Guantai Rd., Houjie
Town, Dongguan City,
Guangdong 523942, China

Tel.: +86 769 8593 5656
Fax: +86 769 8593 1080
Email: customerservice.dg@cn.bureauveritas.com

Page 14 of 17

Report Version 1

Bureau Veritas Shenzhen Co., Ltd.
Dongguan Branch

No. 34, Chenwulu Section, Guantai Rd.,
Houjie Town, Dongguan City, Guangdong
523942, China
Page 114 of 127

Tel: +86 769 8593 5656
Fax: +86 769 8599 1080
Email: customerservice.dg@cn.bureauveritas.com
TEST REPORT EN 50438 VER.1



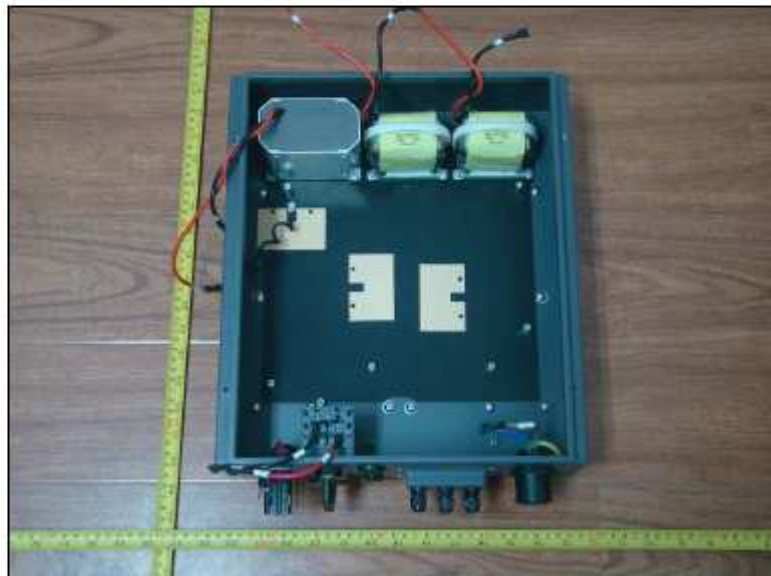



Annex 2

Pictures of the unit

Enclosure front view



Enclosure rear view

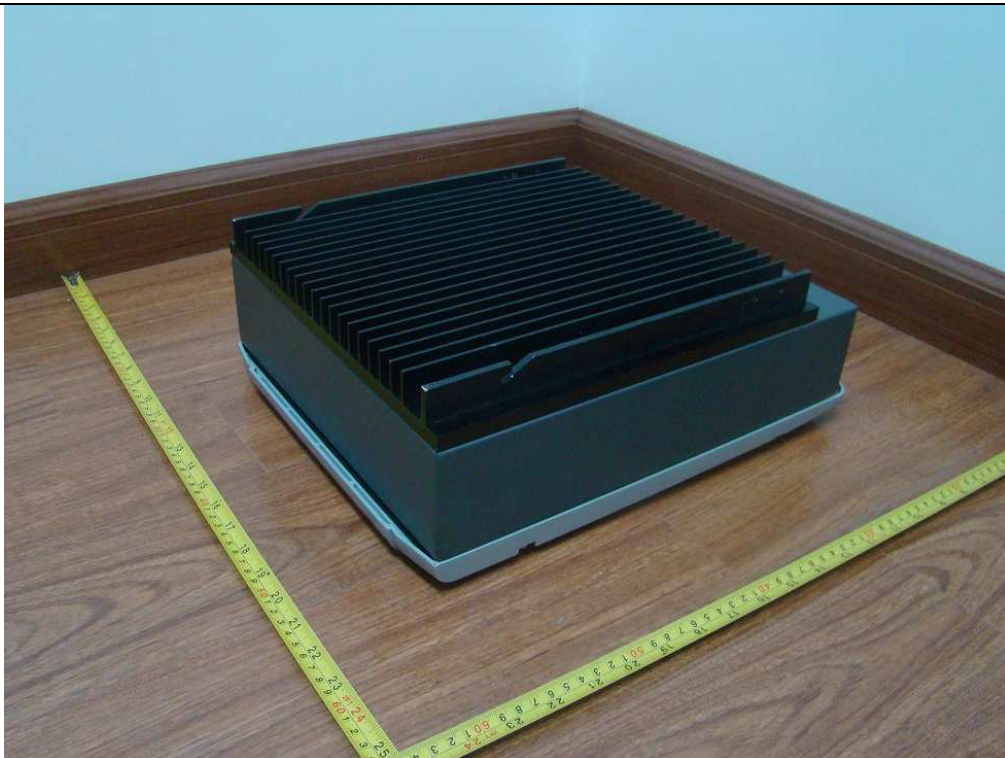

Enclosure bottom view



Internal view-1

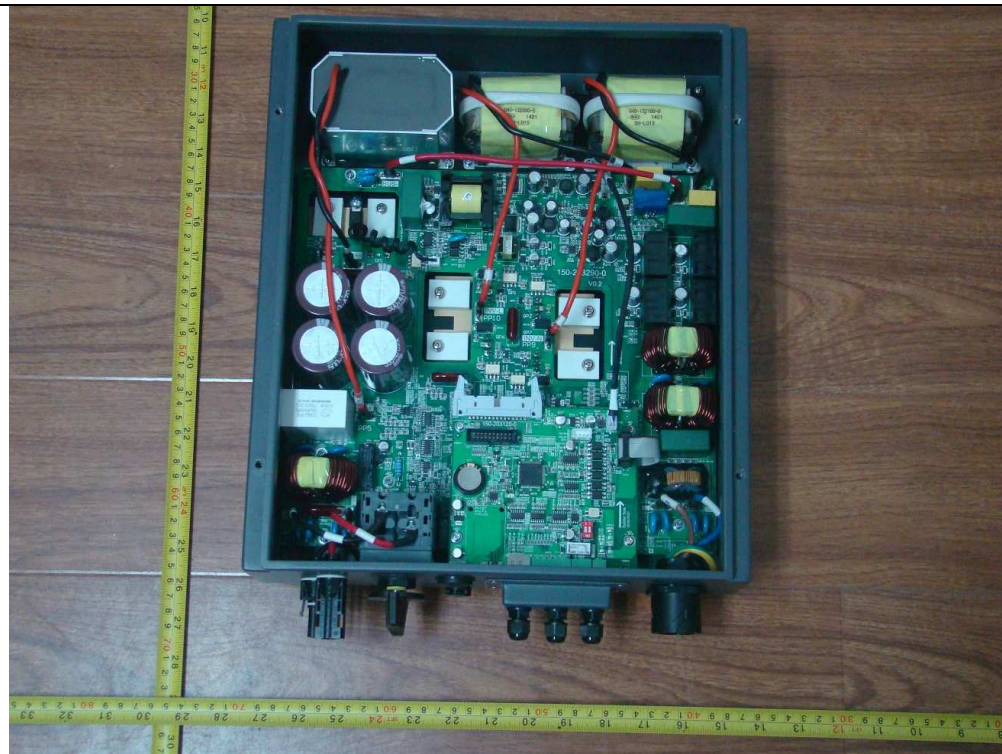

Internal view-2



Internal view-3

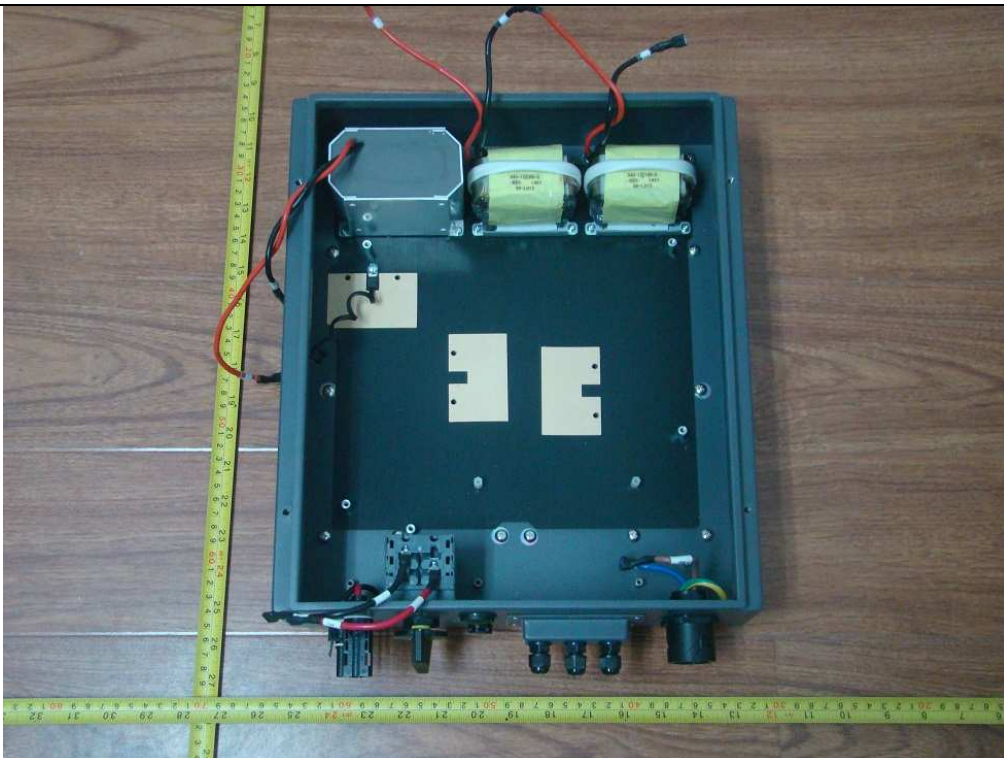

Internal view-4



Main power board component side view



Main power board solder side view

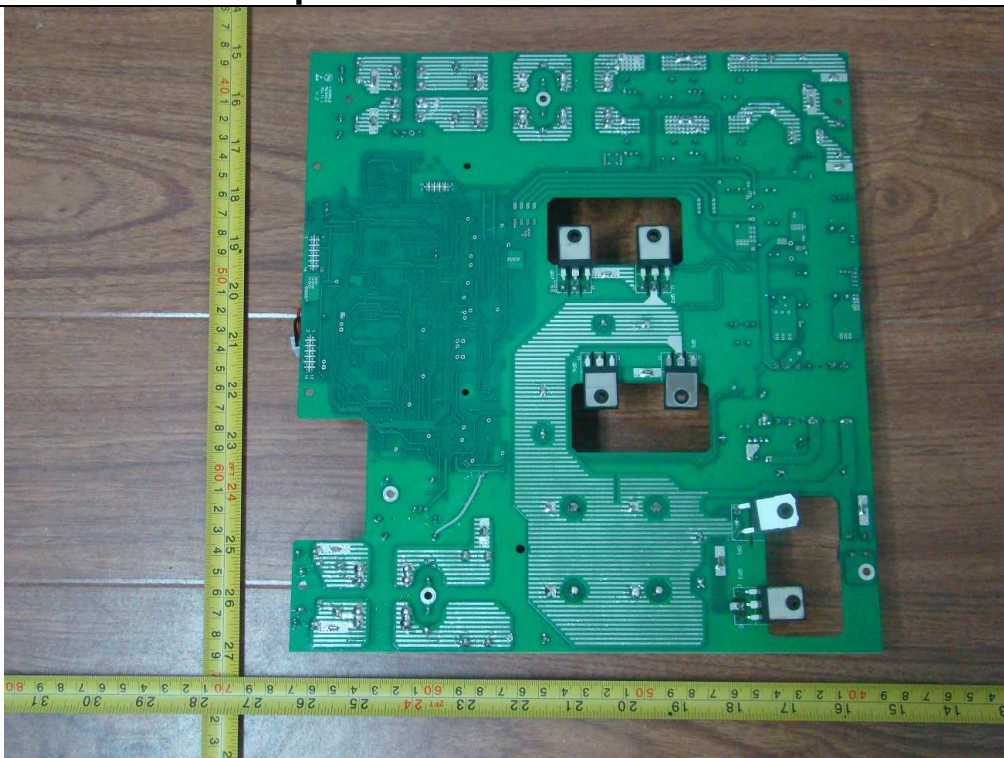

Control board component side view

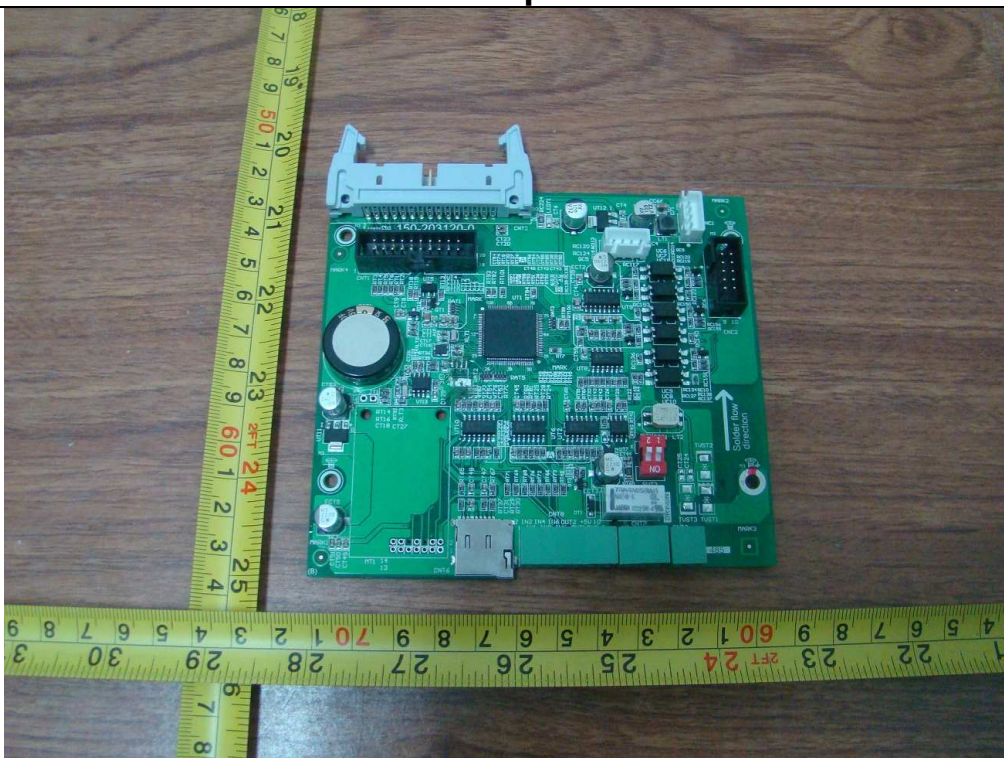

Control board solder side view

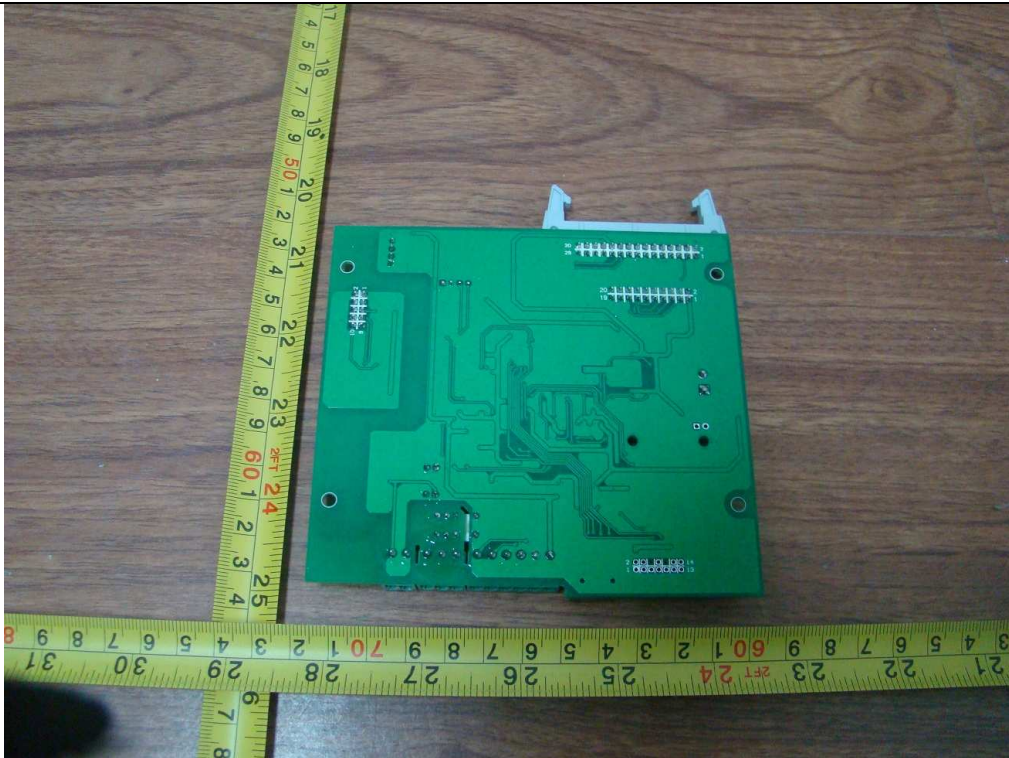

Display board component side view

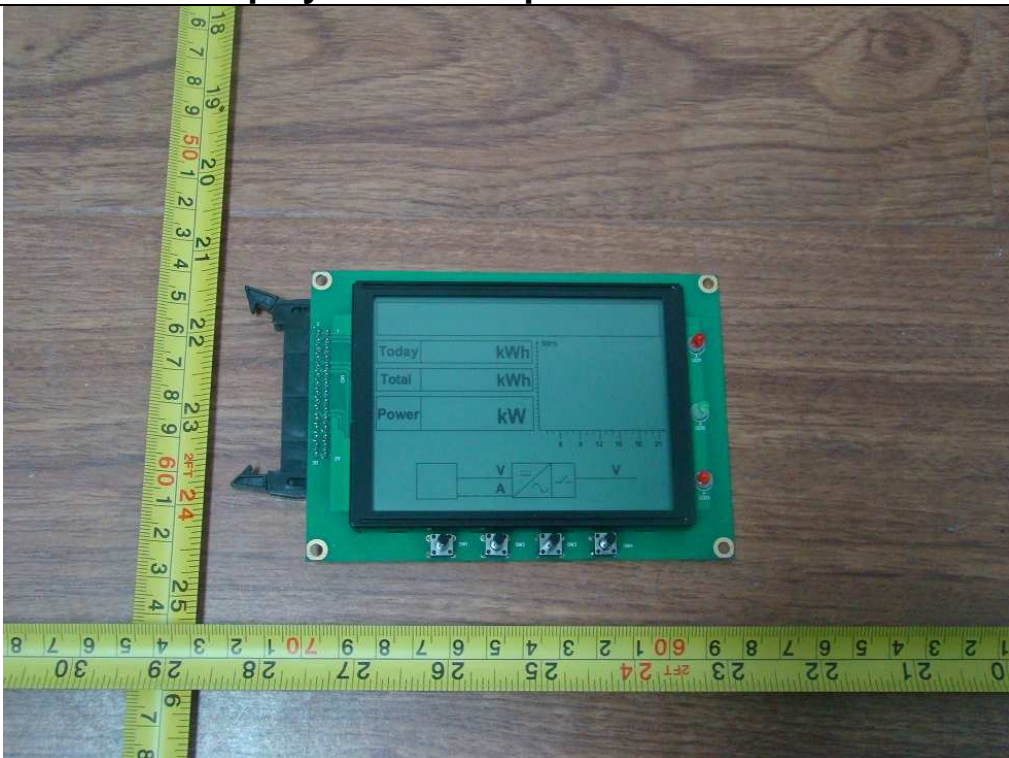

Display board solder side view

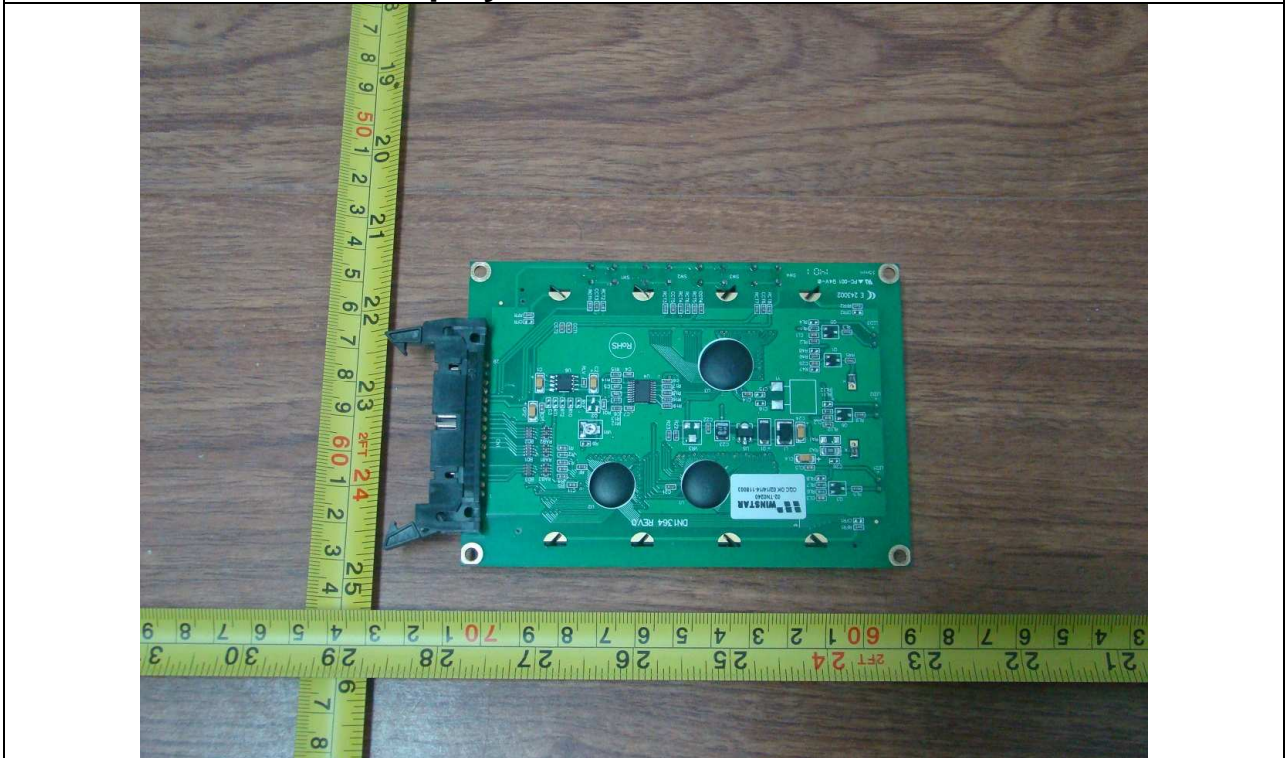

Annex 3

Test equipment list

Equipment	Internal No.	Manufacturer	Type	Serial No.	Last Calibration
Power Analyzer	A4080002DG	YOKOGAWA	WT3000	91M210852	Mar. 12, 2014
AC Source	A7040019DG	Chroma	61512	61512000439	Monitored by Power Analyzer
AC Source	A7040020DG	Chroma	61512	61512000438	Monitored by Power Analyzer
DC Simulation Power Supply	A7040015DG	Chroma	62150H-1000S	62150EF00488	Monitored by Power Analyzer
DC Simulation Power Supply	A7040016DG	Chroma	62150H-1000S	62150EF00490	Monitored by Power Analyzer
Four Channel Digital Phosphor Oscilloscope	A4089003DG	Tektronix	DPO4104B	C010624	Oct. 17, 2013
Current transducer	A1060007DG	YOKOGAWA	CT200	1130700012	Jan 20, 2014
RLC Load	A7150027DG	Qunling	ACLT-3803H	93VOO2869	Monitored by Power Analyzer
Oscilloscope probe	A4089010DG	Tektronix	TPP1000	C008228	Dec. 20, 2013
Oscilloscope probe	A4089011DG	Tektronix	TPP1000	C008229	Dec. 20, 2013
LCR Hitester	A1060006DG	HIOKI	3535	120112505	Mar. 06, 2014